

# SERVICE MANUAL





# BASEBALL PRO.™



[ IMPORTANT ]

- ▶ Please read the manual carefully and keep it in mind before using this machine
- ▶ Put this manual within touch of your reference in anytime.

ISSUE DATE: Mar. 3, 2022

PRODUCT INFO	PART INFO	SUPPORT INFO	NEW PRODUCT INFO
			

※ QR(SUPPROT) - Leaflets, manuals, solution(error code, trouble shooting document, watch&solve)

# PRECAUTIONS FOR USE

The following safety precautions are given throughout this manual. They must be strictly followed to protect those who install, use or maintain this product as well as to protect players, visitors and property.

## For safety reasons.

- The following suggestions should be adhered to:



**WARNING**

Disregarding could result in serious injury.



**CAUTION**

Disregarding could result in injury or product damage.

- The following graphic suggestions describe the types of precautions to be followed.



Indicates a care should be taken.



Forbidden.



Indicates a matter which must be performed.

- **Precautions to be followed:**

**Certain procedures require a qualified in-shop maintenance person or industry specialist. For such instructions, a qualified person must take care of the jobs.**

- Otherwise an electric shock, machine trouble, or a serious accident may result.
- Replacing the machine parts, inspecting and maintaining the machines, and troubleshooting must be assigned only to a qualified in-shop maintenance person or industry specialist. This booklet gives instructions that hazardous jobs in particular must be handled by an industry specialist. Qualified in-shop maintenance person and industry specialist are defined as follows.

### **Qualified in-shop maintenance person**

- A service staff shall have experience in operations of game machines. The staff shall be responsible for assembly, installation, inspection and maintenance of the machine.

### **Industry specialist**

- An industry specialist must be engaged in designing, manufacturing, inspecting and servicing amusement machines. He or she must have an education in electrical, electronic and mechanical engineering, and routinely maintain and repair amusement machines.

# PRECAUTIONS FOR USE

## WARNING

**Be sure to consult an industry specialist when setting up, moving or transporting this product.**

- This product should not be set up, moved or transported by any one other than an industry specialist.
- When installing this product, set the 4 leg levelers evenly on the floor and make sure that the product is installed stably in a horizontal position. Unstable installation may result in injury or accident.
- When installing this product, do not apply undue force on movable parts. Otherwise, injury and accident may result, or the product may be damaged.

**The machine for indoor usage only does not install outside.**



**Do not set the game machine up near emergency exits.**



**Protect the game machine from:**

- Rain or moisture.
- Direct sunlight.
- Direct heat from air-conditioning and heating equipment, etc..
- Hazardous flammable substances.
- Otherwise an accident or malfunction may result.



**Do not place containers holding chemicals or water on or near the game machine.**



**Do not place objects near the ventilating holes.**



**Do not bend the power cord by force or place heavy objects on it.**



**Never plug or unplug the power cord with wet hands.**



**Never unplug the game machine by pulling the power cord.**



## CAUTION

**Be sure to use indoor wiring within the specified voltage requirements. For extension cord, use the specified rating or more.**

**Be sure to use the attached power cord.**

**Never plug more than one cord at a time into the electrical receptacle.**



**Do not lay the power cord where people walk through.**



**Be sure to ground this product.**



**Do not exert excessive force when moving the machine.**



**For proper ventilation, keep the game machine 100mm(4") away from the walls.**

**Do not alter the system related dipswitch settings.**

# PRECAUTIONS FOR USE

## WARNING

**If there is any abnormality such as smoke, bad smell or abnormal noise being emitted from the machine, immediately turn OFF the main power switch and unplug the power cord from the receptacle to stop operating it.** 

- Using the machine in abnormal conditions could result in fire or accidents.

### In case of abnormality

1. Turn OFF the main power switch.
2. Unplug the power cord from the receptacle.
3. Contact your nearest dealer.

**Do not leave the power cord plugged in improperly or covered with dust.** 

- Doing so could result the power cord periodically.

## CAUTION

**Do not use this product anywhere other than industrial areas.** 

- Using in a residential area or an area next to a residential area could affect signal reception of radios, television sets, telephones, etc..
- Do not give shock the surface of glass products.

- Please do not play this game if
  - When you do drinking;
  - When your physical condition is not normal;
  - When you are in pregnancy;
  - When you have on a pulse controller;
  - When you have recently experienced a cramp or fainting away while watching TV.
- Avoid excessive force/shock while playing/moving the game.
- While do games, pay attention to surrounding.

**Do not plug or unplug the power cord with wet hands.** 

**In handling the power cord, follow the instructions below.** 

- |   |  |
|---|--|
| • Do not damage the power cord.           | • Do not modify the power cord.            |
| • Do not bend the power cord excessively. | • Do not twist the power cord.             |
| • Do not heat the power cord.             | • Do not pull the power cord.              |
| • Do not bind the power cord.             | • Do not stand on the power cord.          |
| • Do not sandwich the power cord.         | • Do not drive a nail into the power cord. |

**If the power cord or power plug becomes damaged, stop using the machine immediately and ask your nearest dealer to replace the parts.**

**\* Electromagnetic wave may cause unexpected noise from speaker.**

# PRECAUTIONS FOR USE

## ⚠ WARNING

Be sure to turn OFF the main power switch and unplug the power cord from the receptacle before inspecting or cleaning the machine.



When replacing parts, be sure to use parts of the correct specifications. Never use parts other than the specified ones.



Opening inside the machine shall be done by machine specialist only as high electric current is being sent inside. For game machine with monitor, a care should be taken while opening its back door. If not, a damage to the inside parts or the monitor may occur.



If the sub power switch of the service panel is turned OFF without turning OFF the main power switch of the power supply unit, some parts in the units remain live. When opening the back door, be sure to turn OFF the main power switch and unplug the power cord from the receptacle.



Strictly refrain from disassembly and repair of parts which are not indicated in this manual, as well as settings and remodeling.



To clean the game machine, wipe it with a soft cloth dampened in a neutral detergent.

- Using thinner or other organic solvent or alcohol may decompose the material.
- Electrical shock or equipment failure could be caused by water entering the inside of the machine.

## ⚠ CAUTION

Components in the game are sensitive to vibrations and impact. Care should be used when moving and transporting the game machine.



Be sure not to let the machine tip over.

Before moving the machine, be sure to turn OFF the main power switch, unplug the power cord from the receptacle and remove the power cord from the machine.



Before moving take the machine, off the levelers and move it on the casters.

Avoid excessive force while moving the machine.

.....

## PRECAUTIONS IN HANDLING

- When setting up, inspecting, maintaining, moving or transporting this product, follow the procedures and instructions set forth in this manual and perform such work safely.
- Do not set up, handle, inspect, maintain, move or transport this product under conditions equivalent to the condition of "WARNING" or "CAUTION" specified in this manual.
- If a new owner is to have this product as a result of transfer, etc., be sure to give this manual to the new owner.

# PRÉCAUTION D'EMPLOI

Les consignes de sécurité suivantes sont données dans ce manuel. Elles doivent être strictement suivies pour protéger ceux qui les installent. Utiliser ou entretenir ce produit pour la sécurité des utilisateurs, des visiteurs et des biens.

Pour des raisons de sécurité.

- **Les suggestions suivantes doivent être respectées:**

## **ATTENTION**

Le non-respect peut entraîner des blessures graves.

## **PRUDENCE**

Le non-respect peut entraîner des blessures ou des dommages au produit.

- **Les suggestions graphiques suivantes décrivent les types de précautions à prendre.**



Indique qu'attention est requise.



Interdit.



Indique que quelque chose doit être effectuée.

- **Les précautions à prendre :**

**Certaines procédures exigent une personne de maintenance qualifiée en atelier ou un spécialiste de l'industrie. Pour ces instructions, une personne qualifiée doit prendre soin des travaux.**

- Sinon, un choc électrique, un dysfonctionnement de la machine, ou un accident grave peut en résulter.
- Remplacement des pièces de machines, l'inspection et la maintenance des machines, et le dépannage doit être attribué qu'à une personne de maintenance qualifiée en atelier ou spécialiste de l'industrie. Cette brochure donne des instructions que les emplois dangereux, en particulier, doivent être traités par un spécialiste de l'industrie. La personne de maintenance qualifiée en atelier et le spécialiste de l'industrie sont définis comme suit.

### **La personne de maintenance qualifiée en atelier**

- Un personnel de service doit avoir de l'expérience dans les opérations de machines de jeux. Le personnel est responsable pour l'assemblage, l'installation, l'inspection et l'entretien de la machine.

### **Le spécialiste de l'industrie**

- Un spécialiste de l'industrie doit être engagé dans la conception, la fabrication, l'inspection et l'entretien des appareils d'amusement.  
Il ou elle doit avoir une formation en génie électrique, électronique et mécanique, et de maintenir régulièrement et de réparer les appareils d'amusement.

# PRÉCAUTION D'EMPLOI

## ATTENTION

Si il y a une anomalie comme fumée, mauvaise odeur ou bruit anormal émis par la machine,  couper immédiatement l'interrupteur principal et débranchez le câble d'alimentation de la prise pour arrêter son fonctionnement.

- L'utilisation de l'appareil dans des conditions anormales peut provoquer un incendie ou un accident.

En cas d'anomalie

1. Mettez l'interrupteur principal sur ARRÊT.
2. Débranchez le câble d'alimentation de la prise.
3. Contactez votre revendeur le plus proche.

**Ne pas brancher le câble d'alimentation incorrectement ou le laisser être recouvert de poussière.** 

Cela pourrait nuire le câble d'alimentation.

## PRUDENCE

**Ne pas utiliser ce produit ailleurs que dans les zones industrielles.** 

- L'utiliser dans une zone résidentielle ou d'une zone à côté d'un quartier résidentiel pourrait nuire à la réception des radios, téléviseurs, téléphones, etc.
- Ne donnez pas de choc à la surface d'un produit en verre.

- S'il vous plaît ne pas jouer à ce jeu.
  - Quand vous buvez;
  - Lorsque votre condition physique n'est pas normale;
  - Lorsque vous êtes dans une période de grossesse;
  - Lorsque vous avez un contrôleur d'impulsion;
  - Lorsque vous avez récemment subi une crampe ou évanouissement en regardant la télévision.
- Évitez une force excessive / un choc pendant la lecture / de déplacer le jeu.
- Quand vous jouez les jeux, faites attention aux alentours.

**Ne pas brancher ou débrancher le câble d'alimentation avec les mains mouillées.** 

**Dans la manipulation du câble d'alimentation, suivez les instructions ci-dessous.** 

- |  |   |
|--|---|
| • Ne pas endommager le câble d'alimentation.                 | • Ne pas modifier le câble d'alimentation.            |
| • Ne pas plier le câble d'alimentation de manière excessive. | • Ne tordez pas le câble d'alimentation.              |
| • Ne pas chauffer le câble d'alimentation.                   | • Ne tirez pas sur le câble d'alimentation.           |
| • Ne pas lier le câble d'alimentation.                       | • Ne montez pas sur le câble d'alimentation.          |
| • Ne pas prendre en sandwich le câble d'alimentation.        | • Ne pas mettre un clou dans le câble d'alimentation. |

**Si la fiche du câble d'alimentation ou est endommagé, cessez immédiatement d'utiliser la machine et demandez à votre revendeur le plus proche de remplacer les pièces.**

# PRÉCAUTION D'EMPLOI

## ⚠ ATTENTION

**Assurez-vous de consulter un spécialiste de l'industrie lors de la mise en place, du déplacement ou le transport de ce produit.**

- Ce produit ne doit pas être mis en place, déplacé ou transporté par une quelconque autre qu'un spécialiste de l'industrie.
- Lors de l'installation de ce produit, installez 4 niveleurs de pieds uniformément sur le sol et assurez-vous que le produit est installé de façon stable dans une position horizontale. Une installation instable peut entraîner des blessures ou un accident.
- Lors de l'installation de ce produit, ne pas appliquer une force excessive sur les pièces mobiles. Sinon, des blessures et des accidents peuvent y résulter, ou le produit peut être endommagé.

**La machine pour une utilisation en intérieur uniquement, ne pas installer à l'extérieur.**



**N'installez pas la machine de jeu près des issues de secours.**



**Protéger la machine de jeu de:**



- L'humidité ou la pluie.
- La lumière directe du soleil.
- La chaleur directe de la climatisation et du chauffage, etc...
- Des substances inflammables dangereuses.
- Sinon, un accident ou un dysfonctionnement.

**Ne pas placer les récipients contenant des produits chimiques ou de l'eau sur ou près de la machine de jeu.**



**Ne placez pas d'objets à proximité des orifices de ventilation.**



**Ne pas plier le cordon d'alimentation par la force ou de placer des objets lourds au-dessus.**



**Ne jamais brancher ou débrancher le cordon d'alimentation avec les mains mouillées.**



**Ne jamais débrancher la machine de jeu en tirant le câble d'alimentation.**



## ⚠ PRUDENCE

**Veillez à utiliser le câblage intérieur selon les exigences de tension spécifiées. Pour une rallonge, utilisez la notation spécifiée ou plus.**

**Veillez à utiliser le cordon d'alimentation fourni.**

**Ne jamais brancher plus d'un cordon à la fois dans la prise électrique.**



**Ne pas poser le cordon d'alimentation où les gens marchent à travers.**



**Soyez sûr de mettre à la terre ce produit.**



**Ne pas exercer une force excessive lors du déplacement de la machine.**



**Pour une ventilation correcte, garder la machine de jeu 100mm (4 ") loin des murs.**

**Ne pas modifier les réglages des commutateurs DIP liées au système.**





# PRÉCAUTION D'EMPLOI

## ATTENTION

Veillez à éteindre l'interrupteur d'alimentation principale et débranchez le cordon d'alimentation de la prise avant d'inspecter ou de nettoyer la machine. 

Lors du remplacement des pièces, veillez à utiliser une partie des spécifications correctes. Ne jamais utiliser de pièces autres que celles spécifiées. 

L'ouverture à l'intérieur de la machine doit être effectuée par le spécialiste de la machine seulement, comme le courant électrique élevé est transmis à l'intérieur. Pour la machine de jeu avec le moniteur, un soin doit être pris lors de l'ouverture de sa porte arrière. Si non, une détérioration des pièces à l'intérieur ou à l'écran peut se produire. 

Si l'interrupteur secondaire du panneau de service est éteint sans éteindre le commutateur d'alimentation principale de l'unité d'alimentation, certaines parties dans les unités restent sous tension. Lors de l'ouverture de la porte arrière, veillez à éteindre l'interrupteur d'alimentation principale et débranchez le cordon d'alimentation de la prise. 

Il est strictement conseiller de s'abstenir de démonter et de réparer des pièces qui ne sont pas indiqués dans ce manuel, ainsi que les paramètres et le remodelage. 

Pour nettoyer la machine de jeu, l'essuyer avec un chiffon doux imbibé avec un détergent neutre.

- L'utilisation plus mince d'un autre solvant organique ou de l'alcool peut décomposer le matériel.
- Un choc électrique ou une défaillance de l'équipement pourraient être causés par la pénétration de l'eau à l'intérieur de la machine.

## PRUDENCE

Les composants de la machine de jeu sont sensibles aux vibrations et aux chocs. Il faut faire attention lors du déplacement et le transport de la machine de jeu. 

Veillez à ne pas laisser la machine se renverser.

Avant de déplacer la machine, veillez à éteindre l'interrupteur d'alimentation principale, débranchez le cordon d'alimentation de la prise et débranchez le cordon d'alimentation de la machine. 

Avant de déplacer la machine, la mettre hors des niveleurs et le déplacer sur les roulettes.

Éviter une force excessive lors du déplacement de la machine.

.....

## PRÉCAUTIONS LORS DU MANIEMENT

- Lors de la mise en place, l'inspection, l'entretien, déplacement ou le transport de ce produit, suivez les procédures et les instructions énoncées dans ce manuel et effectuer ce travail en toute sécurité.
- Ne pas mettre en place, manipuler, inspecter, entretenir, déplacer ou transporter ce produit dans des conditions équivalentes à l'état de "ATTENTION" ou "PRUDENCE" spécifiée dans ce manuel.
- Si un nouveau propriétaire obtient ce produit à la suite d'un transfert, etc., soyez sûr de donner ce manuel au nouveau propriétaire.

# CONTENTS

1. SPECIFICATION AND DIMENSION	.....P02	7. TROUBLESHOOTING	.....P20
1-1. DIMENSION	.....P02	7-1. IN CASE OF POWER FAILURE	.....P20
1-2. SPECIFICATION	.....P02	7-2. MOTOR ERROR	.....P21
1-3. NAME OF PARTS	.....P03	7-3. MICRO SWITCH ERROR	.....P22
1-4. STICKER LOCATION	.....P04	7-4. COIN SELECTOR ERROR	.....P23
1-5. COMPONENTS	.....P05	7-5. TICKET DISPENSER ERROR	.....P24
2. INSTALLATION	.....P06	7-6. SOUND ERROR	.....P25
2-1. INSTALLATION SPACE	.....P06	7-7. SETUP LCD PCB ERROR	.....P26
2-2. HOW TO INSTALL	.....P07	7-8. BUTTON & COUNTER ERROR	.....P27
3. GAME CHARACTERISTICS	.....P08	7-9. MOUND LED, OUT LED L,R, LEFT SIDE LED, RIGHT SIDE LED... ERROR	.....P28
4. HOW TO PLAY	.....P08	8. EXPLODED VIEW	.....P29
5. SETUP SETTING	.....P09	8-1. MAIN CABINET PART	.....P29
5-1. MACHINE SETUP	.....P09	8-2. BILLBOARD PART	.....P30
5-2. SETUP MODE	.....P10	8-3. BACKBOARD PART	.....P31
5-3. TEST MODE	.....P14	8-4. DROP PART	.....P32
5-4. ERROR CODE	.....P17	8-5. GROUND PANEL PART	.....P33
6. HOW TO REPLACE MAJOR COMPONENTS	.....P18	8-6. ELEVATOR PART	.....P34
6-1. Replacing MAIN PCB	.....P18	8-7. FRONT DOOR PART	.....P35
6-2. Replacing COIN SELECTOR & SPEAKER & TICKET DISPENSER	.....P18	8-8. POWER PART	.....P35
6-3. Replacing MOTOR	.....P19	8-9. SERVICE PANEL PART	.....P36
		8-10. AC INPUT PART	.....P36
		8-11. MAIN PCB PART	.....P37
		9. BLOCK DIAGRAM	

# 1. SPECIFICATION AND DIMENSION

## 1-1. DIMENSION

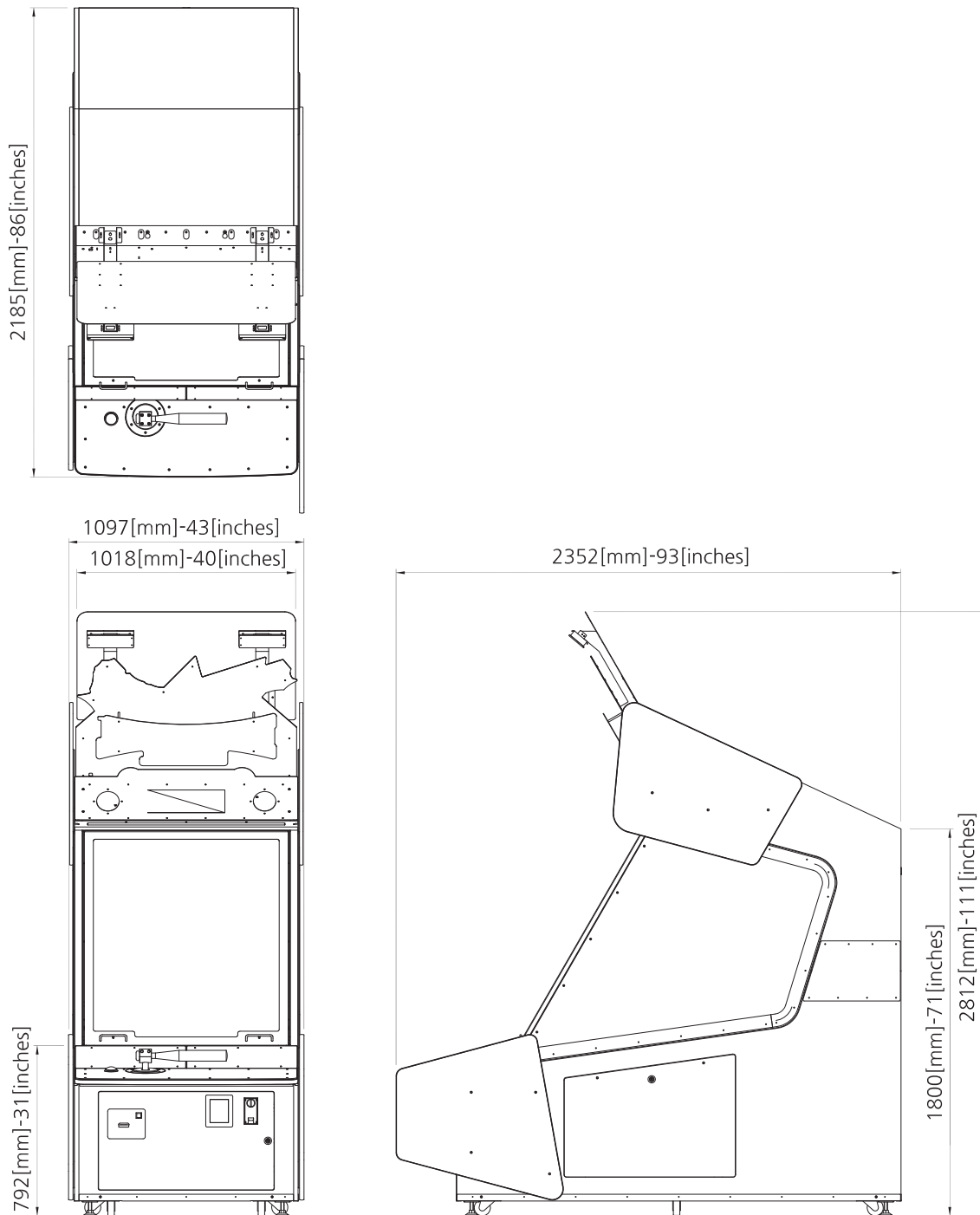

## 1-2. SPECIFICATION

DIMENSION (W x D x H)	1097 x 2352 x 2812 (mm)
PACKING DIMENSION (W x D x H)	1150 x 2280 x 2240 (mm)
WEIGHT (kg)	420 kg [ WEIGHT INCLUDING : 450 kg ] PACKAGING ]
VOLTAGE	AC 120V
FREQUENCY RANGE	60Hz
CONSUMPTION	160 W

\* The 120V voltage specification is for the Americas only, and the 230V (50/60Hz) voltage specifications are for other countries.

# 1-3. NAME OF PARTS

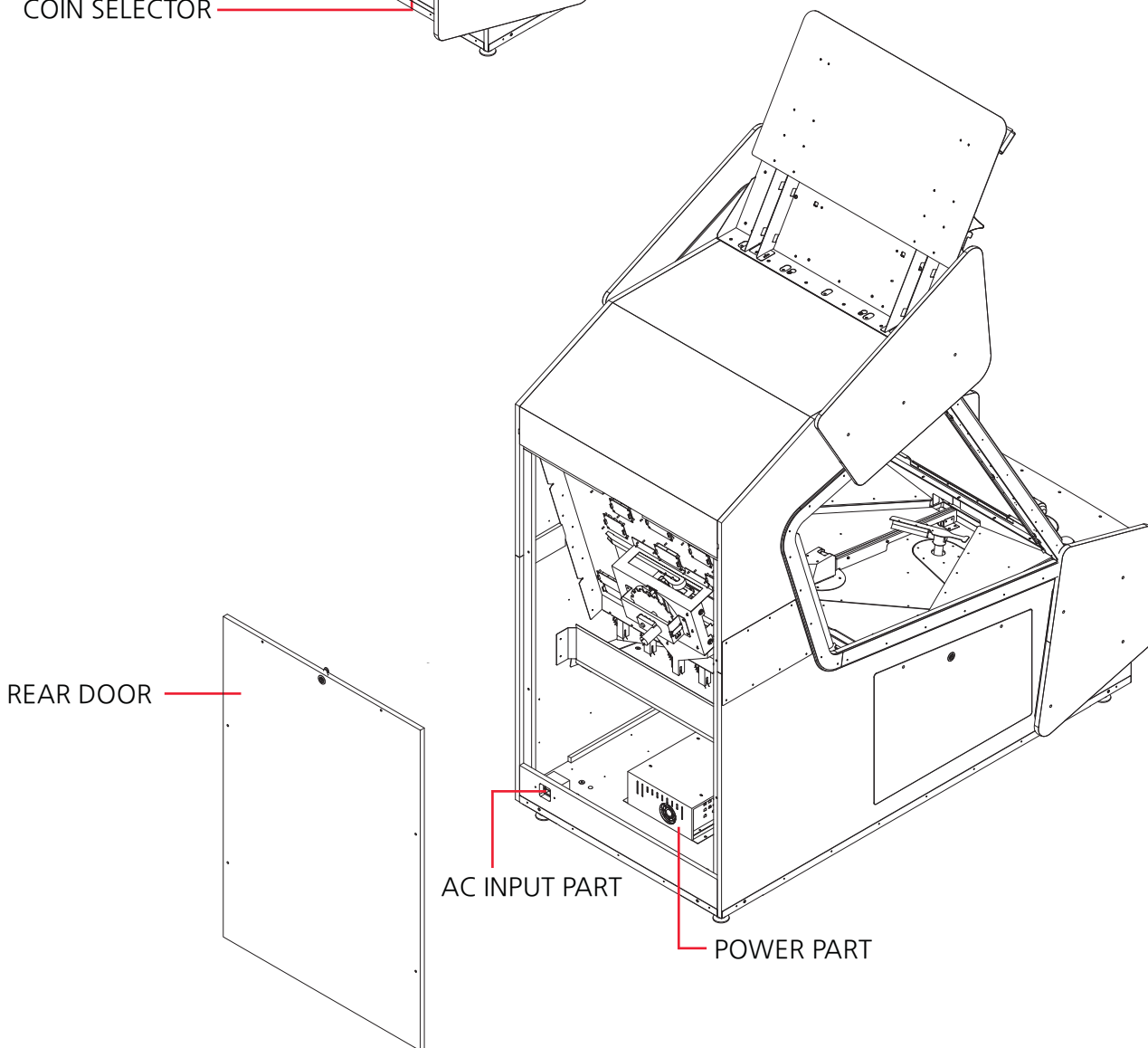
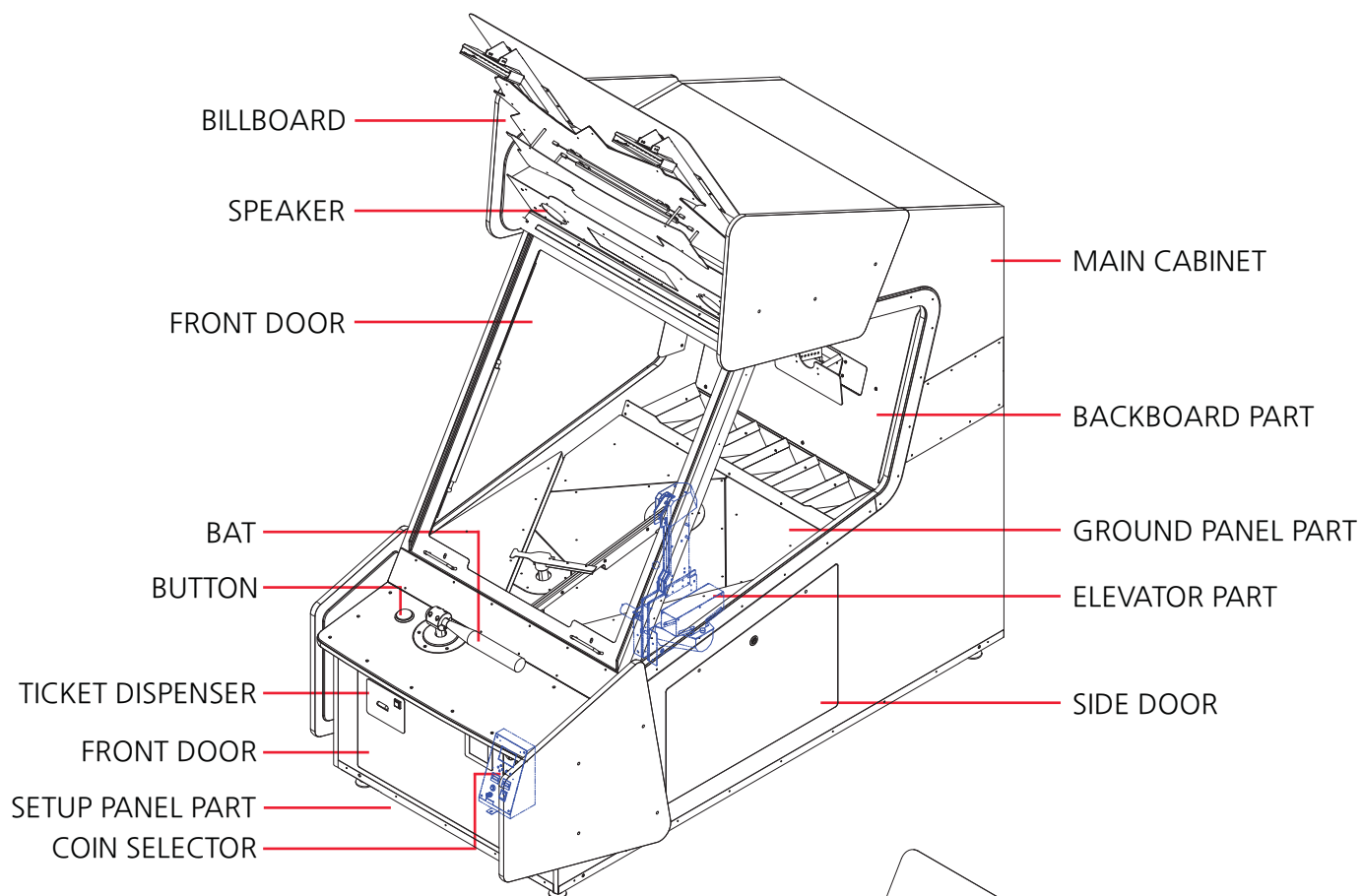

# 1-4. STICKER LOCATION

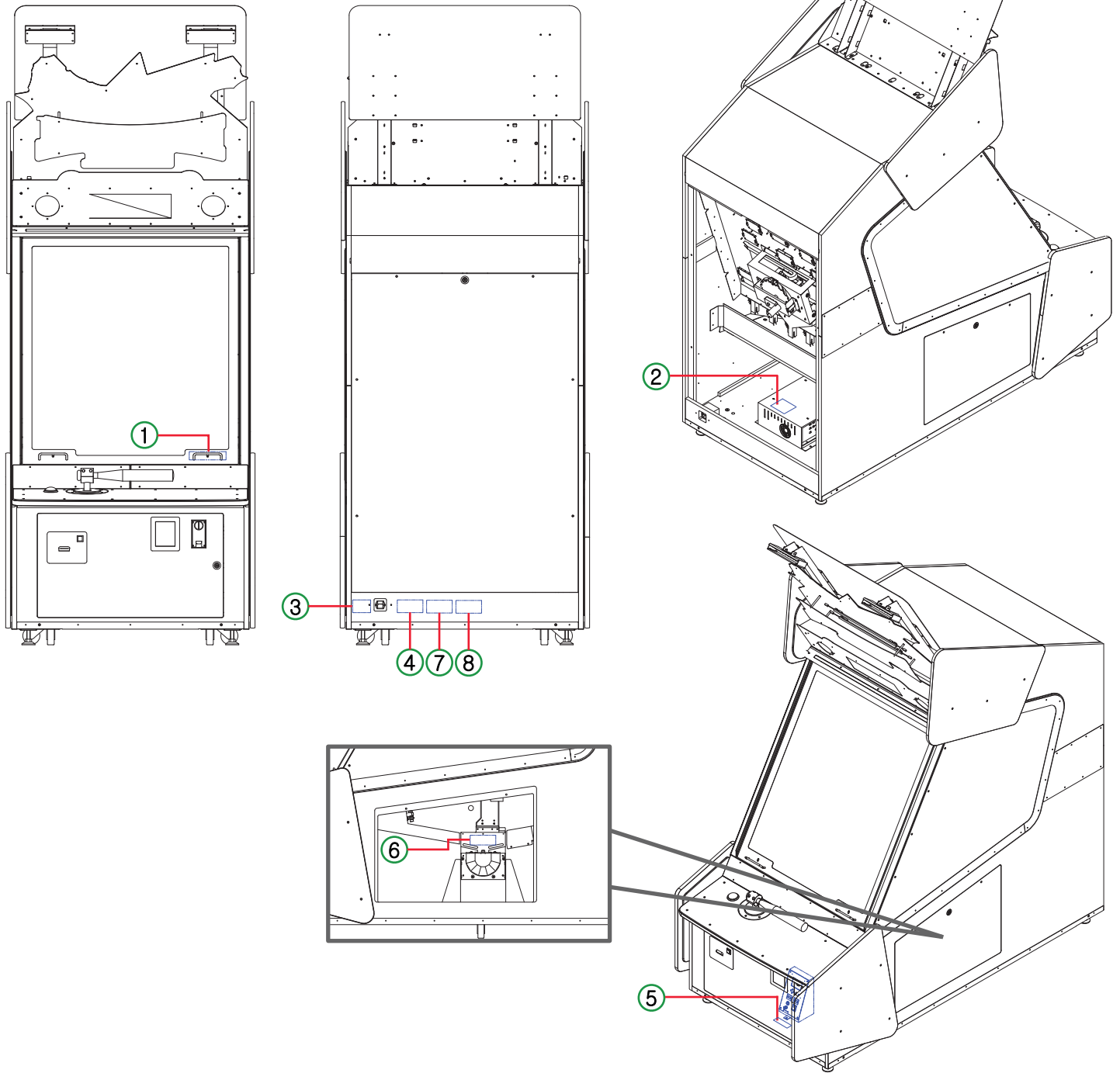

1

**CAUTION/PRUDENCE**

**Do not push or hit this. It would be damaged.**

**Ne pas la pousser ou frapper. Elle serait endommagée.**

2

**WARNING/ATTENTION**

Except service personnel, please never open the product as there is a risk of electric shock.

Il y a un risque d'électrocution, n'ouvrez pas le produit excepté le responsable, s'il vous plaît.

3

**CAUTION/PRUDENCE**

"For continuous protection against risk of fire, replace only with the same type 10A-250V fuse"

"Pour une protection continue contre les risques d'incendie, remplacer un fusible avec seulement le même type 10A-250V"

4



5

**NOTICE**

To turn the power switch on from off status, Please try it in 10 seconds from your turning Off

6

**NOTICE**

BALL SIZE  
25mm

Use the balls supplied by manufacturer only. Do not use the balls except from ANDAMIRO.

7

**WARNING**

ROCKING, SHAKING, OR TIPPING MAY CAUSE INJURY OR DEATH!  
This unit must be fastened securely to the wall, floor or adjacent object in compliance with the installation instructions.

**ATTENTION**

AGITER, SECOUER OU BASCULER PEUT CAUSER DES BLESSURES OU ENTRAINER LA MORT!  
Cette unité doit être fixée au mur, au plancher ou à un objet à proximité conformément aux instructions d'installation.

8

Product Name: GAME MACHINE  
Model No.: BASEBALL PRO  
Rating: 120V~, 60Hz, 220W  
Web site: <http://www.andamiro.com>







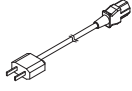

**ANDAMIRO**  
MADE IN KOREA

Serial Number

**ETL**  
US  
Intertek  
5001493

CONFORME TO CANADA, USA, CE, EN 60335-1, EN 60335-2-1  
A SANS COUPE, SANS COUPE, SANS COUPE  
Suitable for Indoor Use Only

## 1-5. COMPONENTS

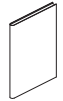
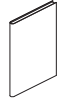
NO.	PART NAME	SPEC.	QTY
1	AC POWER CORD	- 	1
2	KEY	6001, 7001 	EACH 2
3	BOLT	M4x8L 	14
4	BOLT	M6x16L 	4
5	BOLT	M6x20L 	4
6	BOLT	M6x35L 	8
7	BOLT	M6x60L 	16
8	WRENCH	2.5, 3, 5, 8mm 	EACH 1
9	CLEANER	- 	1
10	MANUAL	- 	1
11	TROUBLE SHOOTING MANUAL	- 	1

## 2. INSTALLATION

### 2-1. INSTALLATION SPACE

- Need to have installation place.  
Maintenance Zone & Play zone should have at least 2000mm x 3500mm each.

#### IMPORTANT

- Once you set up the machine with required game-play area, when installing this product, set the 4 leg levelers evenly on the floor and make sure that the product is installed stably in a horizontal position. Otherwise the set winning percentage can be twisted.

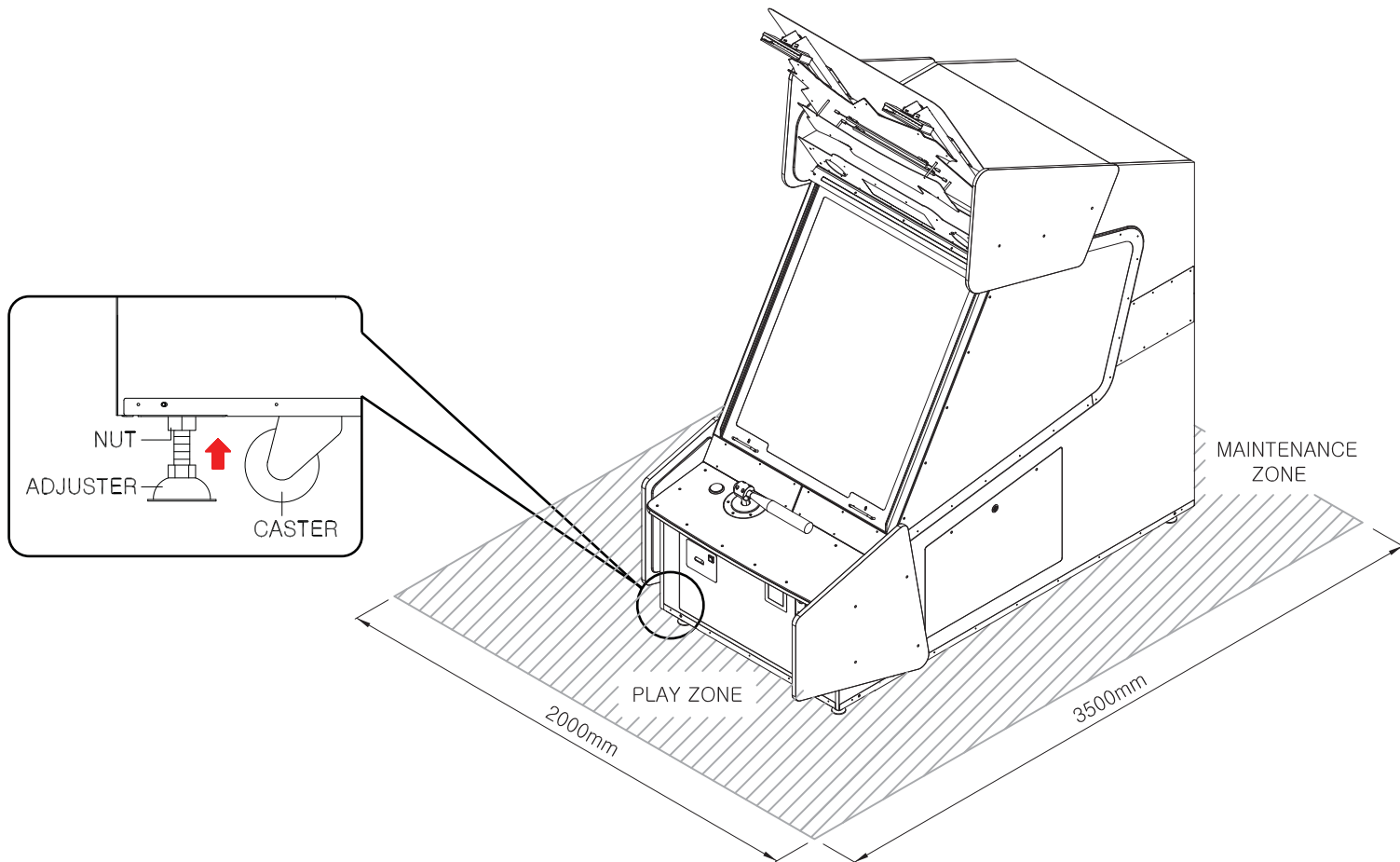

## 2-2. HOW TO INSTALL

\* 30 BALLS are in the elevator.

1

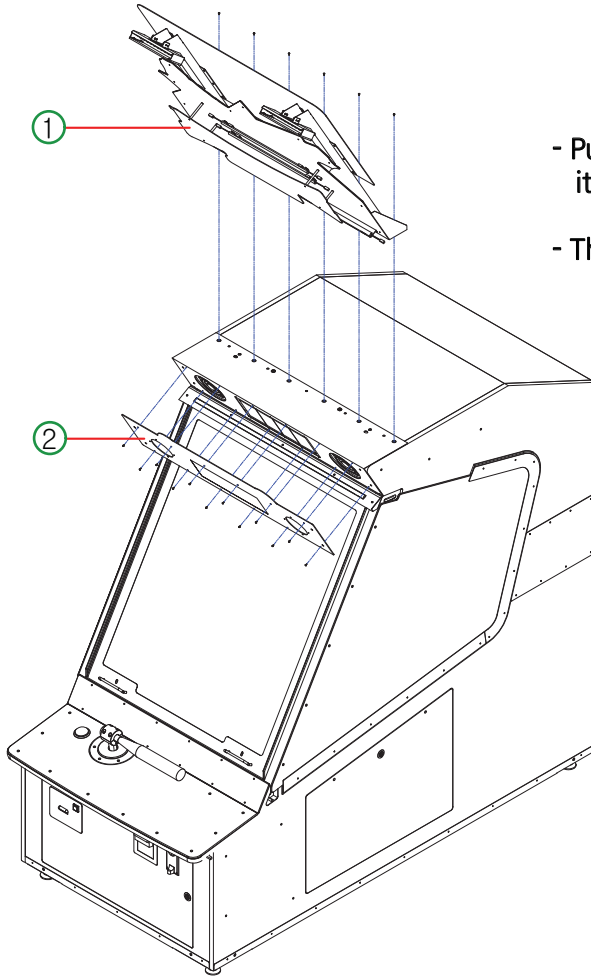

- Put ① BILLBOARD ASS'Y on top of cabinet and assemble it with the fixed bolts [M6 Bolts, 6EA]
- Then, Assemble ② SPEAKER PANEL ACRYL [M4 Bolts, 12EA]

3



- You complete it like picture.

2

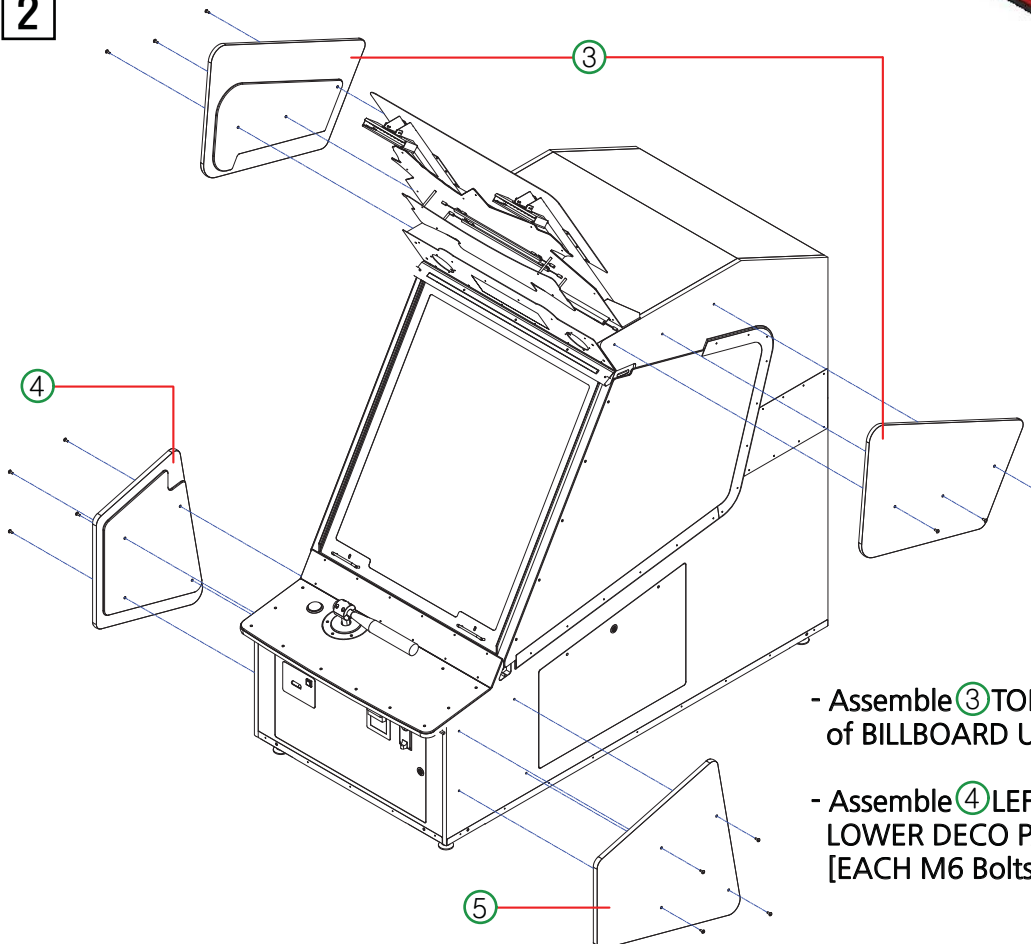

- Assemble ③ TOP DECO PANEL L,R on left and right of BILLBOARD UPPER SIDE [EACH M6 Bolts, 3EA]
- Assemble ④ LEFT LOWER DECO PANEL, ⑤ RIGHT LOWER DECO PANEL on left and right of button panel [EACH M6 Bolts, 4EA]



### 3. GAME CHARACTERISTICS

---

#### 3-1. Realistic Baseball Action With Unique Baseball Bat Interface.



### 4. HOW TO PLAY

---



- 4-1. Insert coins or swipe the card through the card reader to start a game.
- 4-2. A player hits the ball rolling from ball releasing point at the center filed by controlling the bat.
- 4-3. Baseball basic rules are applied when the balls enter in each hole of HOMERUN, HIT and OUT.
- 4-4. My runs increase when runners get home.
- 4-5. Game is over when a player makes 3 outs.
- 4-6. A player gets tickets and BIG-WIN depending on total of My RUNS.

# 5. SETUP SETTINGS

## 5-1. MACHINE SETUP

### 1. HOW TO ENTER SETUP MENU

1 There is "Control panel" inside cabinet. User may set any setting using following.

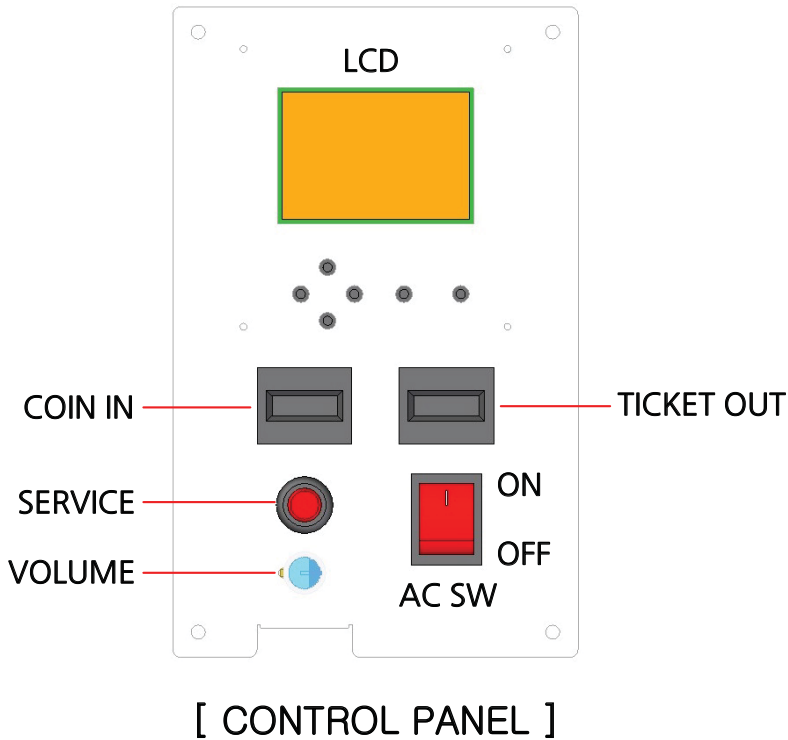

### 2. SETUP BUTTON LAYOUT

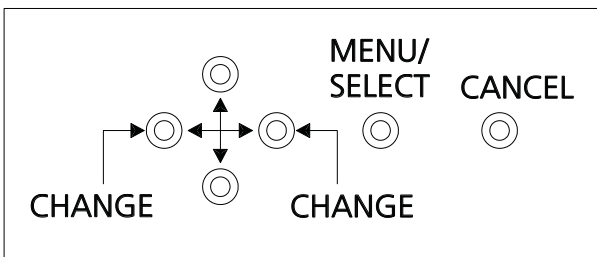

- 1) [ ↑ ↓ ] Up/Down Key : Menu Change
- 2) [ ← → ] Left/Right Key : Setting change
- 3) MENU/SELECT key : Set up Menu mode, Select and Enter
- 4) CANCEL key : Exit
- 5) SERVICE Button : Credit Button

## [ OPERATION MENU ]

PUSH MENU BUTTON . [SELECT BUTTON: ACCESS]	
#OPERATING OPTIONS#	
PROGRAM SETTINGS	SETUP MODE
CLEAR MODE	CLEAR MODE
BOOKKEEPING DATA	BOOKKEEPING
FACTORY SETTING	INITIALIZING FACTORY SETTING
TEST MODE	TEST MODE
EXIT	OPERATION OPTIONS EXIT

## 5-2. SETUP MODE

PROGRAM SETTINGS			
LCD DISPLAY		DESCRIPTION	RANGE
<b>CREDIT/COIN</b>	<b>1/1</b>	SETTING CREDIT / COIN RATE	"FREE", 1/1, 1/2, 1/3, 1/4, 1/5 1/6, 1/7, 1/8, 1/9, 1/10, 2/1, 3/1, 4/1, 5/1
<b>BILL / COIN</b>	<b>1</b>	COIN ADDING VALUE PER BILL INPUT SIGNAL	1 ~ 10
<b>START OUT COUNT</b>	<b>0</b>	INITIAL OUT COUNT	0, 1, 2
<b>3 FOULS OUT</b>	<b>OFF</b>	IN CASE OF FOUL OUT PROCESSING SETTING	"OFF", "ON"
<b>EVENT OPT~ "MONSTER"</b>		SET GAME EVENTS FUNTION "NONE" : NO EVENTS "SLUGGER" : 1 OUT THEN "SLUGGER" CHANCE EVNETN (NO OUT HOLES) "MONSTER" : 2 OUT THEN "MONSTER" CHANCE EVENT (NO OUT HOLES) "ALL" : USING "SLUGGER" & "MONSTER" CHANCE ALL	"NONE", "SLUGGER", "MONSTER", "ALL"
<b>MYRUNS x TICKET</b>	<b>10</b>	SET TICKETS Q'TY PER POINT (MYRUNS)	0 ~ 30 (Increment by 1)
<b>BIGWIN = MYRUNS</b>	<b>15</b>	TARGET POINTS (MYRUNS) FOR BIG WIN (In case of getting points over target points (MYRUNS), win the big win ticket regardless of the option of "MYRUNS x TICKET")	5 ~ 50
<b>TOPSCORE DOWN</b>	<b>30</b>	When the game is played as the number of setting and then not played more than 30 minutes, it decrease 1st Top Score by -1 (After decrease -1 point, game play number will be recounted) (no lower than Big Win set value) (If it is not 1st condition, it decrease on the 2nd, If it is not the 2nd condition, it decrease on the 3rd.)	"None", 10, 20, 30, 50, 70, 100 (Game Play Number)
<b>BIG-WIN VALUE</b>	<b>1000</b>	BIG WIN initial points (No more than BIG-WIN LIMIT value)	100 ~ 3000 (Increment by 50)
<b>BIG-WIN LIMIT</b>	<b>3000</b>	Limit maximum BIG WIN increased by increment per game	100 ~ 5000 (Increment by 50)
<b>BIG INCREMENT</b>	<b>0</b>	BIG-WIN increased value on every game Can not be used with FIXED TICKET, BIGWIN LEVEL option	0 ~ 50 (Increment by 1)

<b>DIFFICULTY</b>	<b>NORMAL</b>	Set Game difficulty. (Based on OUT hole location) "EASY" : located on EASY Goal In "NORMAL" : located on Normal Goal In "HARD" : located on difficult Goal In	"EASY", "NORMAL", "HARD"
<b>MERCY TICKET</b>	<b>0</b>	SERVICE TICKET OUT Q'TY (NON-WINNING SCORE, DISPENSATION TICKET) <b>BE ABLE TO SET MYRUNS x TICKET SET VALUE OR LESS</b>	TILL 0 ~ <b>MYRUNS x TICKET SET VALUE</b> (Increment by 1)
<b>TICKET/SCORE</b>	<b>1/1</b>	SET TICKET RATIO PER SCORE NONE : NO TICKET OUT	"NONE", "1/1", "1/2"
<b>FIXED TICKET</b>	<b>OFF</b>	UNLIMITED TICKETS PER GAME IGNORE MERCY TICKET OPTION CAN NOT BE USED WITH BIG INCREMENT, BIGWIN LEVEL OPTION	OFF, 1~20 (Increment by 1)
<b>BIGWIN LEVEL</b>	<b>OFF</b>	IF NORMAL GETS BIGWIN, BIGWIN SUCCESS SCORE IS INCREASED BY 1 IF YOU WIN THE BIG WIN IN HARD, THE SCORE YOU SCORED IS APPLIED (17 POINTS FOR THE NEXT BIG WIN WHEN THE GAME ENDS), 1 FOR THE TIE	"OFF", "NORMAL", "HARD"
<b>ATTRACT VOLUME</b>	<b>80</b>	SET DEMO SOUND AND VOLUME "OFF" : NO SOUND 10 ~ 100 : SOUND VOLUME RATIO	"OFF", 10 ~ 100 (Increment by 10)
<b>ELEVATOR</b>	<b>150</b>	SET THE BALL RELEASING TIMING FROM BALL ELEVATOR. (TIME OF MOTOR STOP AFTER THE SENCOR DETECTS THE BALL RELEASING SIGNAL, INCREMENT BY MS)	50, 100, 150, 200
<b>SAVE AND EXIT</b>		SAVE AND EXIT	
<b>CANCEL AND EXIT</b>		CANCEL AND EXIT	
<b>CAUTION! IN CASE SET VALUE WITH DISPLAY IS CHANGED, ALL OF INTERNAL BOOKEEPING DATA, GAME DATA &amp; CREDIT &amp; TICKET WILL BE DELETED TOO.</b>			

### CLEAR MODE

- GAME SETTING VALUE MAINTAINS THOUGH GAME DATA IS DELETED.

LCD DISPLAY	DESCRIPTION	PROCESS
CLEAR TICKETS	CLEAR TICKETS	IN CASE OF PUSHING SELECT, [YES] or [NO] CURSOR WILL MOVE AND PERFORM
CLEAR CREDITS	CLEAR CREDITS	
CLEAR DATA	CLEAR TICKETS, CREDITS AND GAME DATA (GAME SETTING VALUE IS SAVED)	
CLEAR TOPSCORE	CHANGE Top Score INTO BASIC SET VALUE.	
	(1st = SET AS BIGWIN POINT 2nd = SET AS 1st - 2 POINTS 3rd = SET AS 2nd - 2 POINTS)	

BOOKKEEPING DATA	
LCD DISPLAY	DESCRIPTION
== BOOKKEEPING == GAMES TICKETS AVERAGE	DISPLAY GAME INFO . TOTAL GAME PLAYS . TOTOL TICKETS OUT . AVERAGE TICKET OUT PER GAME
== TOTAL CREDITS == COINS SERVICE CREDITS	DISPLAYING TOTAL CREDIT INFO . TOTAL INSERTED COINS . TOTAL SERVICE BUTTONS . TOTAL CREDITS
== BIG WIN == SUCCESS TICKETS	TOTLA BIG WIN SUCCESS INFO . BIG WIN SUCCESS Q'TY . BIG WIN TICKETS Q'TY
== BALL COUNT INFO = BALL HIT OUT	THE RESULT INFO AFTER RELEASING ALL BALLS . TOTOAL RELEASED BALLS . HIT + HOME RUN BALLS . OUT + FOUL BALLS
HIT1 HIT2 HIT3 HRUN	BALL Q'TY OF 1 BASE HIT BALL Q'TY OF 2 BASES HIT BALL Q'TY OF 3 BASES HIT BALL Q'TY OF 1 HOME RUN
HOLE1 HOLE2 HOLE3 HOLE4	BALL Q'TY OF GOAL IN HOLE 1 (HOLE NO 1 FROM LEFT SIDE) BALL Q'TY OF GOAL IN HOLE 2 BALL Q'TY OF GOAL IN HOLE 3 BALL Q'TY OF GOAL IN HOLE 4
HOLE5 HOLE6 HOLE7 FOUL	BALL Q'TY OF GOAL IN HOLE 5 BALL Q'TY OF GOAL IN HOLE 6 BALL Q'TY OF GOAL IN HOLE 7 BALL Q'TY OF FOUL
== PLAY TIME INFO == AVG MIN MAX	GAME PLAY TIME INFO . AVERAGE GAME PLAYING TIME . MINIMUM GAME PLAYING TIME . MAXIMUM GAME PLAYING TIME
== MYRUN LEVEL == 0 : 0 1 ~ : 0 3 ~ : 0	COUNTING OF PLAYER'S MY RUN POINTS PLAYERS NO OF 0 POINT PLAYERS NO OF 1~2 POINTS PLAYERS NO OF 3~4 POINTS
5 ~ : 0 7 ~ : 0 10 ~ : 0 12 ~ : 0	PLAYERS NO OF 5~6 POINTS PLAYERS NO OF 7~9 POINTS PLAYERS NO OF 10~11 POINTS PLAYERS NO OF 12~14 POINTS

15 ~ : 0	PLAYERS NO OF 15~16 POINTS
17 ~ : 0	PLAYERS NO OF 17~19 POINTS
20 ~ : 0	PLAYERS NO OF OVER 20 POINTS
JP : 0	Jackpot PLAYER'S Q'TY
** VER INFO INT **	VERSION & GAME OPERATING TIME INFO
V -.-, - - -	. VERSION INFO
RUNTIME h:mm:ss	. TOTAL TIME OF MACHINES ON (hour:min:sec)
PLAYTIME h:mm:ss	. TOTAL PLAY TIME (hour:min:sec)
CANCEL BUTTON : EXIT	

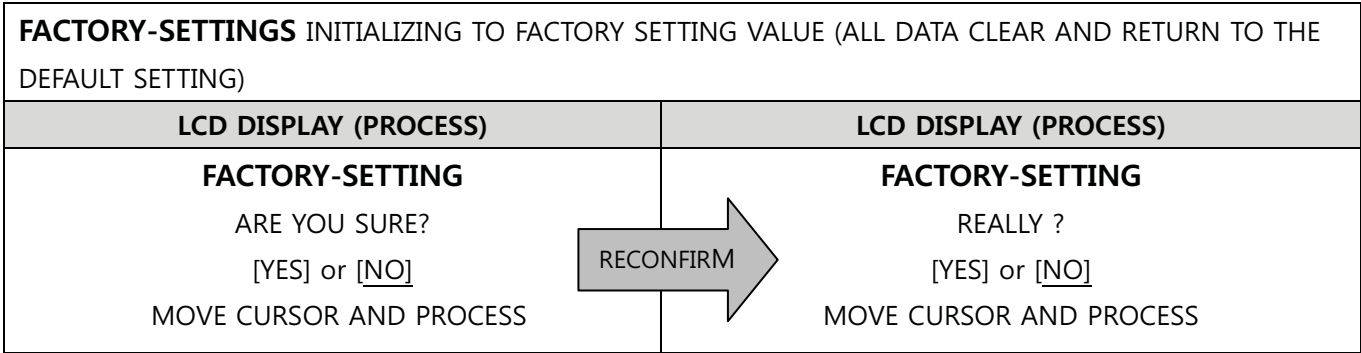

## 5-3. TEST MODE

TEST MODE			
LCD DISPLAY	SET VALUE	DESCRIPTION	
INPUT TEST	BASIC TEST	AT THE STATUS OF CURSOR ON INPUT TEST MENU, BASIC SWITCH STATUS CAN BE CHECKED LED OR LAMP TWINGKLING OR SOUND (One, Two, Three~) COME OUT (One, Two, Three~)	
	[=>]	INTO INPUT STATUS CONFORM MODE (REFER TO INPUT STATUS)	
	MYRUN FND "ON/OFF" DISPLAY	> SET THE INHIBIT TEST WITH REGARD TO IR SENSOR BY USING LEFT / RIGHT KEYS WHEN THE CURSER IS LOCATED ON INPUT TEST (ON, OFF) (HOMERUN IR SENSOR, BALL ELEVATOR RELEASING SENSOR, FOUL OUT SENSOR)	
FND & LAMP	LAMP, FND, LED FUNTION TEST		
	"OFF"	TOTAL OFF .	
	"STEP"	LAMP	TOTAL ON, OFF BLINKING ► TICKET LAMP ► BUTTON LAMP ► FOUL OUT LAMP ► MAIN BACK BOARD LAMP ► DOOR TOP LED BAR ► BILL BOARD LAMP ON REPEATS (FROM THE BOTTOM LINE TO UPPER LINE)
		FND	TOTAL ON, OFF BLINKING -> NUMBER COUNT 1111 ~ 9999 -> CREDIT FND: 11 / RUN TICKET FND 22 / BIG WIN TARGET FND 33 / TICKETS FND : 4444 / MYRUN FND : 55 / 2ND FND: 66 / 1ST FND: 77 / 3RD FND: 88 / BIG WIN FND 9999 DISPLAY CONTINUOULY FIELD FND : FROM LEFT 111, 222, 333, 444, 555, 666 ,777 DISPLAY AND RED, GREEN, DISPLAY COLOR CHANGE
		LED	TOTAL ON, OFF BLINKING ► RED COLOR, LIGHT ON IN SEQUENCE ► RED ► GREEN ► BLUE ► WHITE LIGHT ON
	"ON"	TOTAL ON (UNDER ON STATUS, THIS VALUE WILL BE REMAINED ON OTHER TEST MODES.)	
	"ON/OFF"	TOTAL ON, OFF REPEAT	

HOME RUN MOT	HOME RUN MOVEMENT TEST	
	"OFF"	STOP
	"ON"	MOVING UP AND DOWN
	MY FND DISPLAY : MOTOR MOVEMENT, On, Off DISPLAY [MOVE:On, STOP:off] GOALIN FIELD FND (GREEN COLOR "_"(UNDERBAR) CHANGE INTO 1 WITH INPUT SIGNAL) NO 1 : [E1_] MOTOR ORIGINAL POINT ENCODER SENSOR STATUS NO 2 : [E2_] MOTOR CHANGE POINT ENCODER SENSOR STATUS NO 4 : [Su_] HOMERUN GOALIN SENSOR STATUS NO 5: [I1_] HOMERUN GOALIN IR SENSOR 1 STATUS ("_"(UNDERBAR) CHANGE INTO 1 WITH INPUT SIGNAL NO 6 : [I2_] HOMERUN GOALIN IR SENSOR 2 STATUS ("_"(UNDERBAR) CHANGE INTO 2 WITH INPUT SIGNAL	
ELEVATOR	BALL ELEVATOR MOVEMENT TEST	
	"OFF"	BALL ELEVATOR STOP
	"ON"	BALL ELEVATOR MOVE
	MY FND DISPLAY : MOTOR MOVEMENT, On, Off DISPLAY [MOVE:On, STOP:off] GOALIN FIELD FND (GREEN COLOR "_"(UNDERBAR) CHANGE INTO 1 WITH INPUT SIGNAL) NO 1 : [En_] MOTOR ENCODER SENSOR STATUS NO 3 : [TP_] UPPER BALL SENSOR STATUS NO 5 : [Ot_] BALL RELEASING SENSOR STATUS NO 7 : [b_] SATUS OF INTERAL FOUL BALL RECOGNIZATION SENSOR ON BAT REAR AREA (2PCS) <b>BY LEFT, RIGHT BUTTONS, ADJUST AUTO BALL RELEASING TERM. INCREMENT BY 10. MAXIMUM TILL 300</b> <b>TIME DISPLAY ON TICKETS FND (100 == 1 SECOND)</b>	
COIN	"OFF", "ON"	COIN MECH MOVEMENT
	MY FND DISPLAY : COIN MECH INHIBIT MOVEMENT, On, OFF DISPLAY [MOVE:On, STOP:off] GOALIN FIELD FND (GREEN COLOR "_"(UNDERBAR) CHANGE INTO 1 WITH INPUT SIGNAL) NO 2 : [C1_] COIN MECH 1 SENSOR STATUS NO 3 : [ 0] COIN MECH 1 SENSOR RECOGNIZATION COUNT ( COIN MECH MOVEMENT. IN CASE OF On, Off, IT BECOMES INITIAL VALUE)	
BILL	"OFF", "ON"	BILL ACCEPTOR MOVEMENT
	MY FND DISPLAY : BILL ACCEPTOR INHIBIT MOVEMENT, On, OFF DISPLAY [MOVE:On, STOP:off] GOALIN FIELD FND (GREEN COLOR "_"(UNDERBAR) CHANGE INTO 1 WITH INPUT SIGNAL) NO 1 : [On ] BILL ACCEPTOR MOVEMENT STATUS	



TICKET	"OFF", "ON"	TICKET DISPENSER MOVEMENT TEST(BASIC 3 TICKETS OUT)
	MY FND DISPLAY : TICKET DISPENSER MOVEMENT, On, OFF DISPLAY [MOVE:On, STOP:off] GOALIN FIELD FND (GREEN COLOR "_"(UNDERBAR) CHANGE INTO 1 WITH INPUT SIGNAL)	
	NO 1: [t-1] DIPLAY THE CURRENT TEST TICKET DISPENSER NO	
	NO 2: [S _] TICKET DISPENSER DISPENSING SENSOR STATUS	
	NO 3: [ _ 0] TICKET DISPENSER DISPENSING TICKET NO	
NO 4: [ . . . ] TICKET DISPENSER DISPENSING BUTTON STATUS (IN CASE OF BUTTON INPUT, "btn" DISPLAYS)		
TICKET FND : TICKET DISPENSING Q'TY AND ERROR STATUS (ERROR DISPLAYS AS "Err")		
COUNTER	"COIN"	COIN COUNTER MOVEMENT
	"TICKET"	TICKET COUNTER MOVEMENT
	SELECT IT USING BY LEFT, RIGHT BUTTORNS THEN PUSH THE SELECT BUTTON. 1 COUNTER INCREASES	
SOUND TEST	[=>]	SOUND TEST MODE
EXIT	EXIT SETUP MODE	

### TEST MODE -> INPUT TEST

Input Test DIPLAY THE INPUT AREA CHECKABLE BY EYES ON THE FRONT OF GAME.





















EXIT WITH Cancel BUTTON.

LCD DISPLAY	SET VALUE	DESCRIPTION
GAME BUTTON	Off, On	GAME BUTTON STATUS
TICKET1 SENSOR	Off, On	TICKET DISPENSER 1 SENSOR STATUS
TICKET BUTTON	Off, On	TICKET DISPENSER BUTTON STATUS
COIN 1 SENSOR	Off, On	COIN 1 SENSOR STATUS
BILL SENSOR	Off, On	BILL ACCEPTOR SENSOR STATUS
SETUP UP	Off, On	SETUP UPPER BUTTON STATUS
SETUP DOWN	Off, On	SETUP DOWN BUTTON STATUS
SETUP LEFT	Off, On	SETUP LEFT BUTTON STATUS
SETUP RIGHT	Off, On	SETUP RIGHT BUTTON STATUS
SETUP SELECT	Off, On	SETUP SELECT BUTTON STATUS
SETUP CANCEL	Off, On	SETUP CANCEL BUTTON STATUS
SERVICE BUTTON	Off, On	SERVICE BUTTON STATUS
0 : 0000000000000000	INTERNAL STATUS, SENSOR STATUS TO VERIFY WITH VALUE 0, 1	
1 : 0000000000000000	0 – INPUT	
2 : 0000000000000000	1 – NO INPUT	

### TEST MODE -> SOUND TEST

LCD DISPLAY	SET VALUE	DESCRIPTION
TEST	"Channel"	VOICE OF One, Two, ~ Eight ON EACH CHANNER
	"BGM"	BGM TEST
	"FX"	FX TEST
	"VOC"	VOICE TEST
-EXIT-	RETURN TO PREVIOUS MENU (SETUP MODE) (EXT MENU) SELECT BUTTON : EXIT	

## 5-4. ERROR CODE

ERROR CODE	TICKET FND DISPLAY	ERROR TYPE	NOTE	CHECK LIST
E0-1		SETUP LCD	NO SETUP LCD RESPONSE	CHECK SET UP LCD (GAME WILL BE PLAYED NORMALLY)
E0-2		SYSTEM	FAILURE OF READING AND WRITING OF SET UP SAVED DATA MEMORY	TURN POWMER On, Off. IF IT CONTINUES, SUBSTITUE THE MAINBOARD
E0-3			SAVED SET UP DATA PROBLEM	ENTER INTO SETUP MODE AND CHECK THE SETTING AND SAVE (IF IT CONTINUES, SUBSTITUE THE MAINBOARD)
E0-4			SAVED SET UP DATA PROBLEM	TURN POWMER On, Off. IF IT CONTINUES, SUBSTITUE THE MAINBOARD
E1-1		COIN MECH	CONTINUOUS COIN 1 SENSOR SIGNAL	1. CHECK COIN MECH 1 2. CHECK DIP SWITCH N/O SETTING
E1-3		BILL ACCEPTOR	CONTINUOUS BILL ACCEPTOR SENSOR SIGNAL.	CHECK BILL ACCEPTOR
E6-1		BALL ELEVATOR	NO ENCODER SIGNAL CHANGE	1. CHECK MOTOR MOVEMENT 2. CHECK ENCODER SENSOR STATUS
E6-2			BALL RELEASING PROBLEM	1. CHECK THE BALL EXISTENCE 2. CHECK THE BALL RELEASING SENSOR
E6-3			NO BALL TOP SENSOR SIGNAL	1. CHECK THE BALL EXISTENCE 2. CHECK THE BALL TOP SENSOR
E8-1		GOALIN SWITCH (FROM LEFT GOALIN HOLE, 1, 2, 3, 4, 5, 6, 7) &	CONTINUOUS GOAL IN HOLE NO 1 SWITCH SIGNAL	CHECK GOALIN HOLE NO 1 SWITCH
E8-2			CONTINUOUS GOAL IN HOLE NO 2 SWITCH SIGNAL	CHECK GOALIN HOLE NO 2 SWITCH
E8-3			CONTINUOUS GOAL IN HOLE NO 3 SWITCH SIGNAL	CHECK GOALIN HOLE NO 3 SWITCH
E8-4			CONTINUOUS GOAL IN HOLE NO 4 SWITCH SIGNAL	CHECK GOALIN HOLE NO 4 SWITCH
E8-5			CONTINUOUS GOAL IN HOLE NO 5 SWITCH SIGNAL	CHECK GOALIN HOLE NO 5 SWITCH
E8-6			CONTINUOUS GOAL IN HOLE NO 6 SWITCH SIGNAL	CHECK GOALIN HOLE NO 6 SWITCH
E8-7			CONTINUOUS GOAL IN HOLE NO 7 SWITCH SIGNAL	CHECK GOALIN HOLE NO 7 SWITCH
E8-8		FOUL OUT SENSOR	CONTINUOUS SIGNALS OF HOMERUN INTERANL GOALIN SWITCH	CHECK THE SWITCH OF HOMERUN GOAL IN SWITCH
E8-9			CONTINUOUS SIGNALS OF INTERNAL FOUL OUT SENSOR	CHECK THE SENSOR OF INTERNAL FOUL OUT
E8-a			MORE THAN 3 TIMES TRYING TO RELEASE BALLS NO GOAL IN & INTERNAL FOULD OUT SENSOR SIGANL	1. CHECK GOAL IN SWICH 2. CHECK INTERANL FOUL OUT SENSOR 3. CHECK BALL ELEVATOR STATUS
Et-1		TICKET ERROR	NO TICKET OR NO MOVEMNT OF TICKE DISPENSOR MOTOR	CHECK TICKETS OR MOVEMNT
Et-2			TICKET JAMMED OR ACT IN REVERSE WAY OF TICKET SENSOR	1. CHECK TICKET JAMMED STATUS 2. CHECK THE DIP SWITCH OF TICKET DISPENSOR DIP SWITCH SENSOR

## 6. HOW TO REPLACE MAJOR COMPONENTS

### 6-1. Replacing MAIN PCB

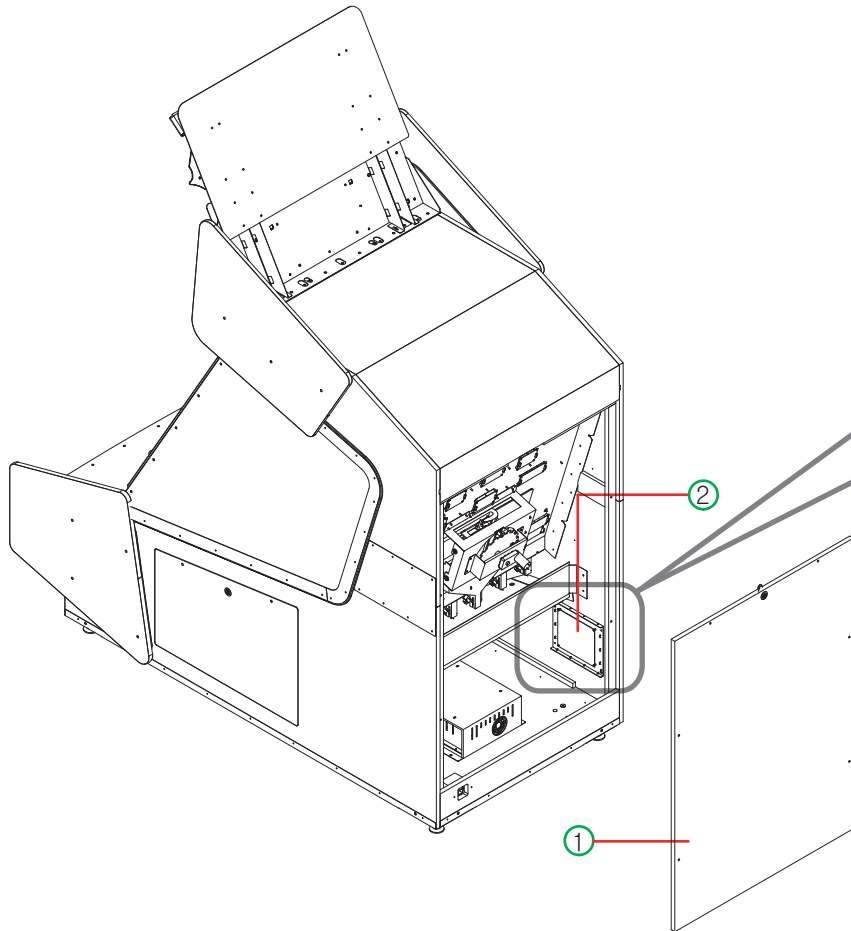

- (1) Open the ① REAR DOOR, There is a ② MAIN PCB. After separate a connected connector, replace a PCB.
- (2) Reassemble them in reverse order.

NO.	PART NAME	SPEC.	CODE NO.
②	MAIN PCB ASS'Y	-	ABAP0PCB007

### 6-2. Replacing COIN SELECTOR & TICKET DISPENSER

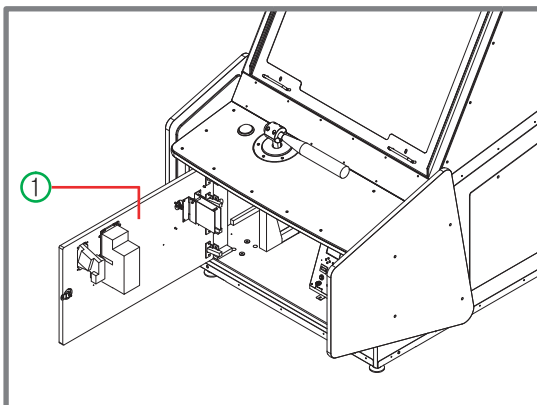

- (1) Open the ① FRONT DOOR.
- (2) Separate a connected connector.
- (3) Separate the bolt or bolt&nut. [M4 Bolts, 4EA]
- (4) Reassemble them in reverse order after replacement.

NO.	PART NAME	SPEC.	CODE NO.
②	COIN SELECTOR	TW-333	MZZZ0COS045
③	TICKET DISPENSER	TL-002H	MZZZ0TID007

## 6-3. Replacing MOTOR

### (1) Replacing HR MOTOR

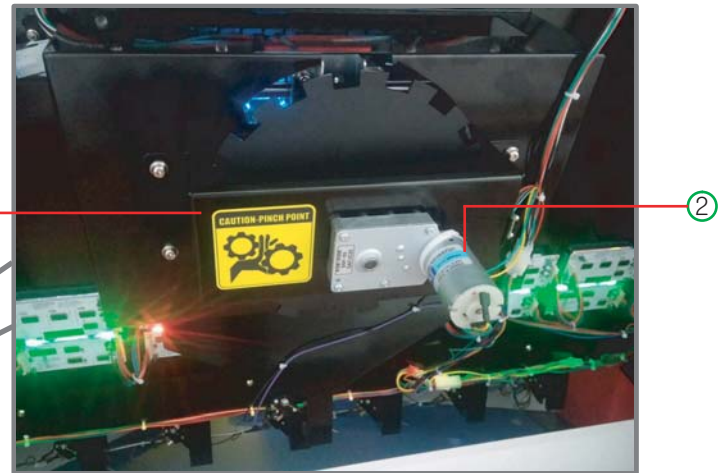
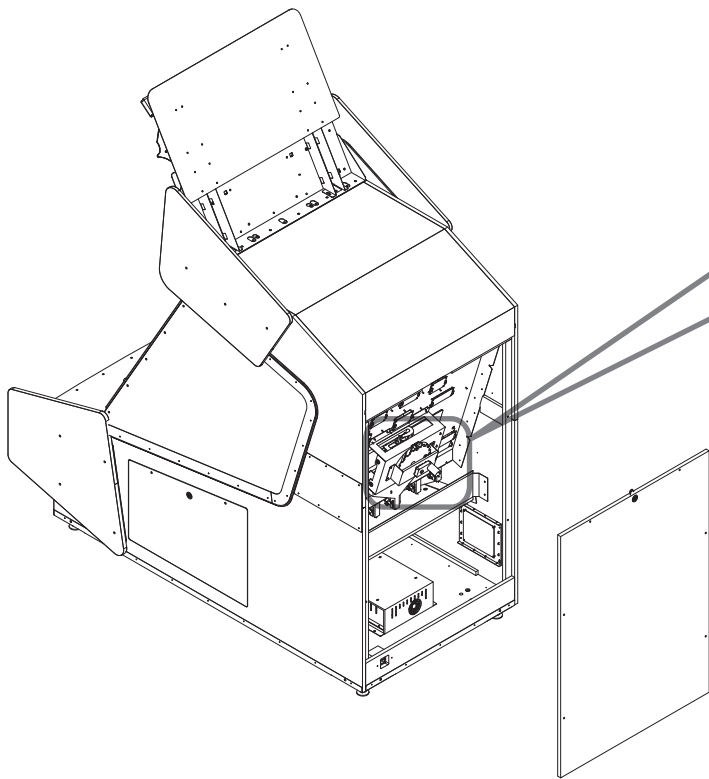

- (1) Open the rear door using the key.
- (2) Separate the connected connector with motor&sensor pcb.
- (3) Disassemble ① MOTOR BKT [M4 Bolts, 4EA]
- (4) Take the MOTOR out by disassembling Motor shaft [M6 WRENCH Bolts, 2EA] Bolts, then exchange it.

NO.	PART NAME	SPEC.	CODE NO.
②	MOTOR	KEG-3657-308/17.8RPM	MZZZ0MOT099

### (2) Replacing ELEVATOR MOTOR

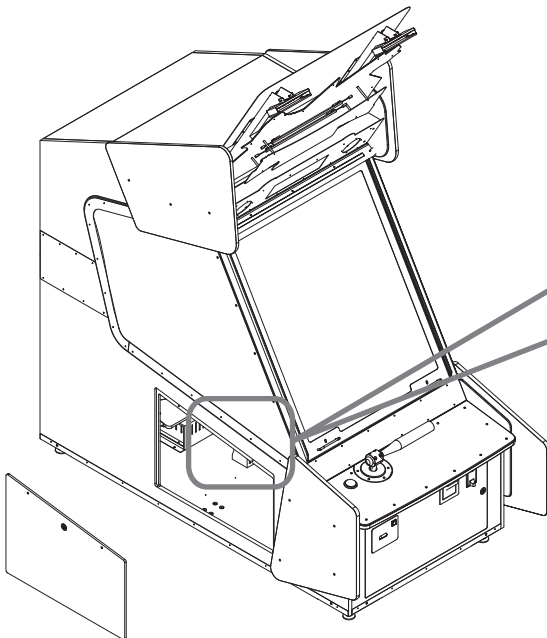

- (1) Open the side door using the key.
- (2) Separate the connected connector with MOTOR,
- (3) Disassemble ① ELEVATOR MOTOR FIX BKT [M4 Bolts, 4EA]
- (4) Release the coupling bolts [M5 WRENCH Bolts, 2EA] connected with a motor then separate the motor then exchange it.

NO.	PART NAME	SPEC.	CODE NO.
③	MOTOR	KEG-3657-615/8.9RPM	MZZZ0MOT100

# 7. TROUBLESHOOTING

## 7-1. IN CASE OF POWER FAILURE

\*Common: Check the input voltage, check wiring

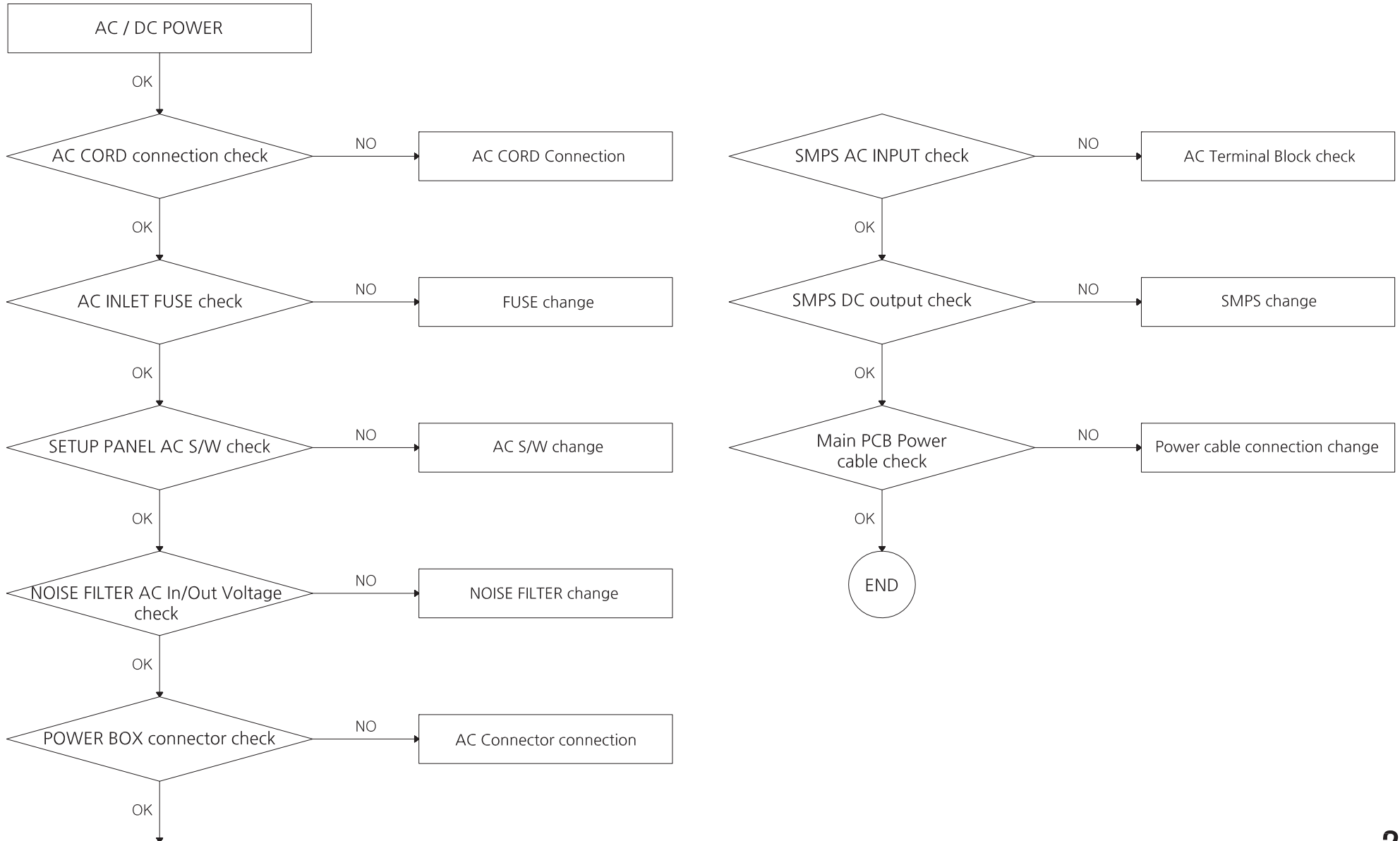

# 7-2. MOTOR ERROR

\*Common: Check the input voltage, check wiring

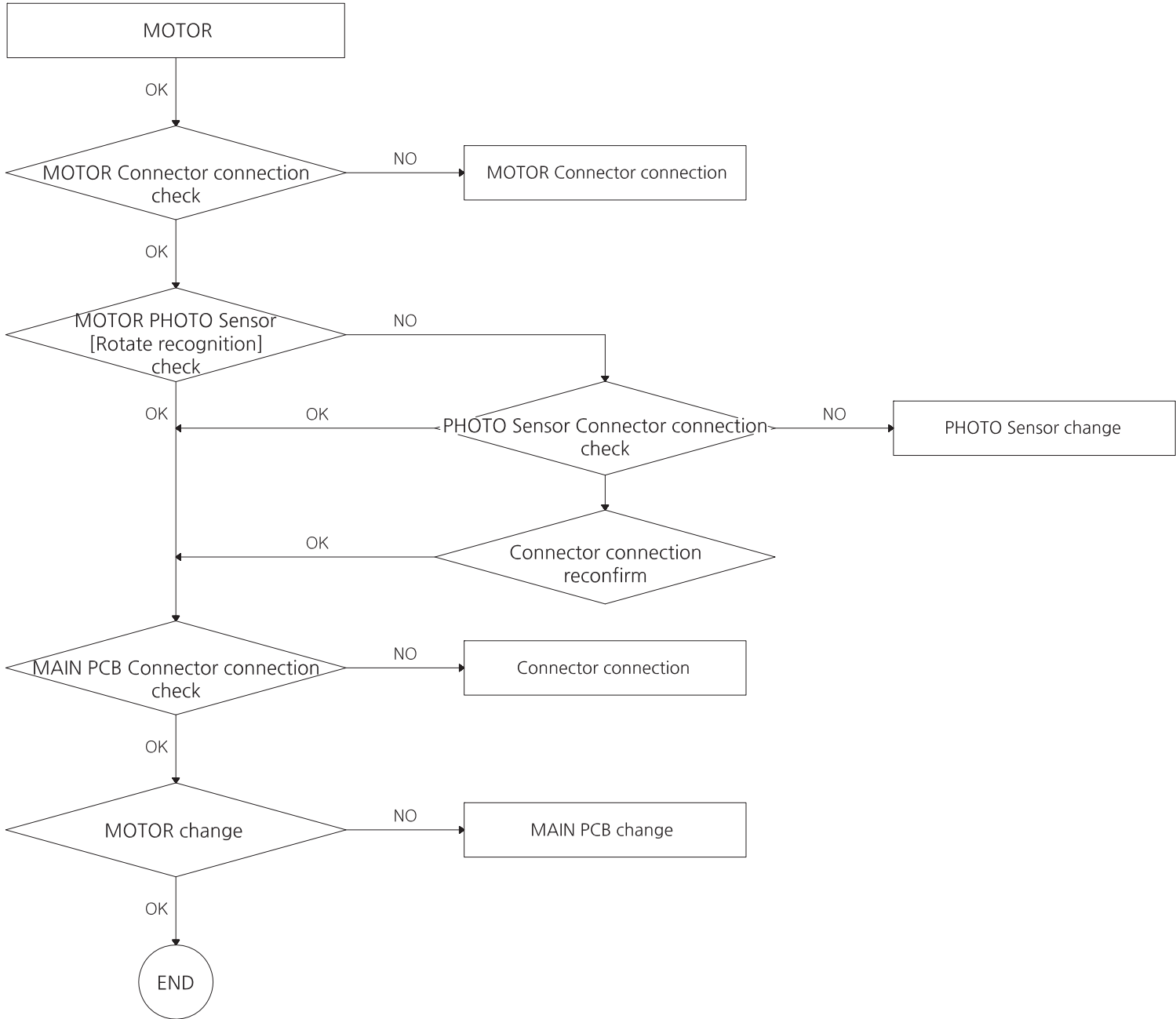

# 7-3. MICRO SWITCH ERROR

\*Common: Check the input voltage, check wiring

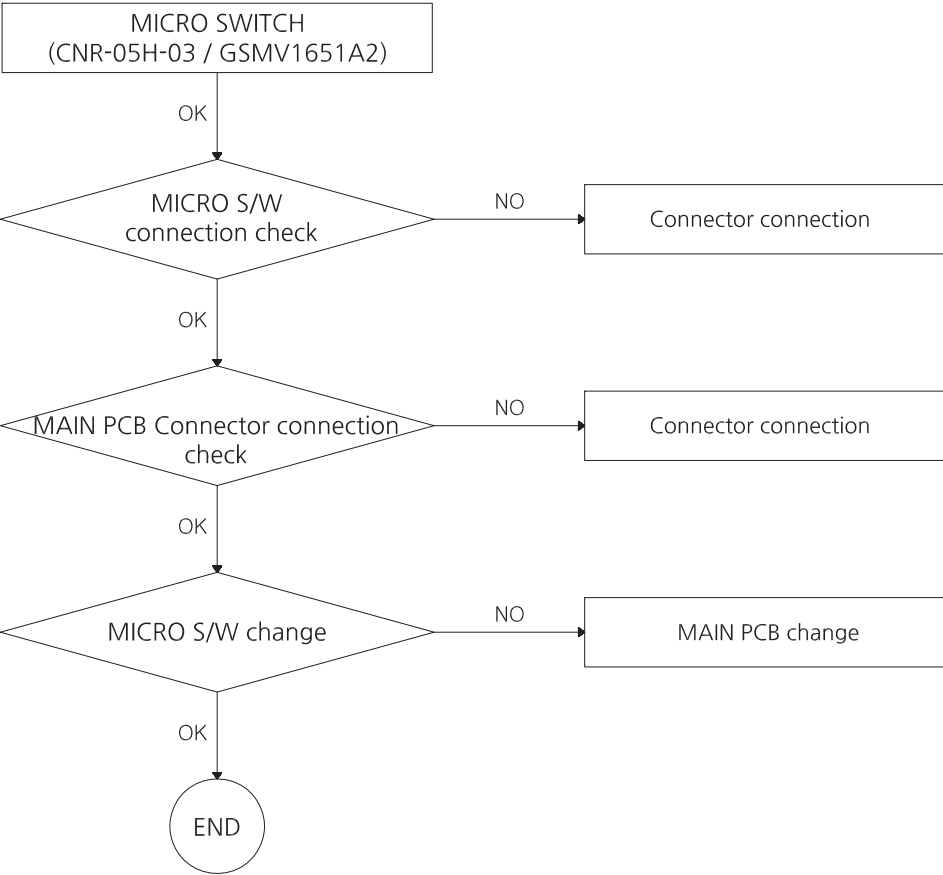

## 7-4. COIN SELECTOR ERROR

\*Common: Check the input voltage, check wiring

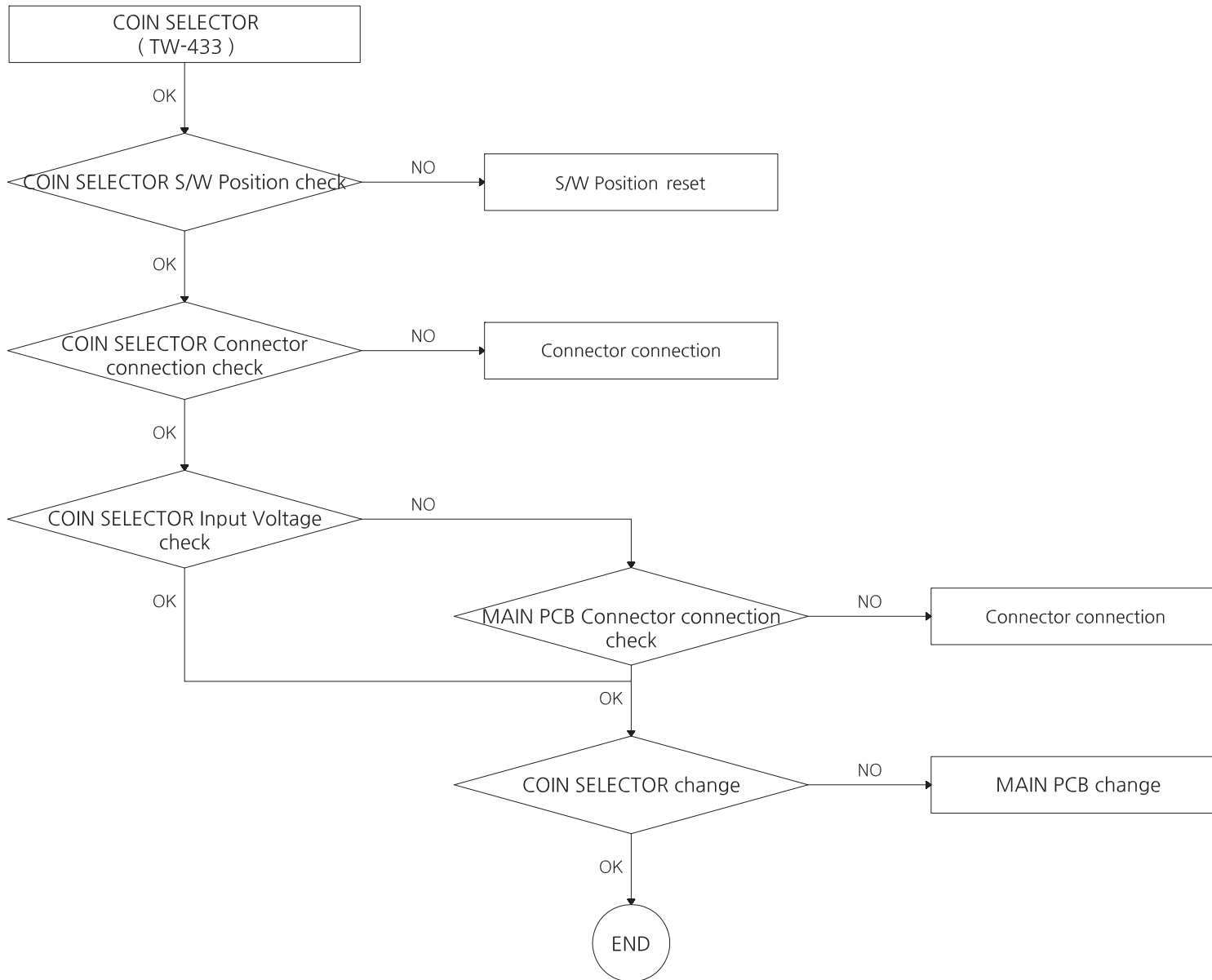



## 7-5. TICKET DISPENSER ERROR

\*Common: Check the input voltage, check wiring

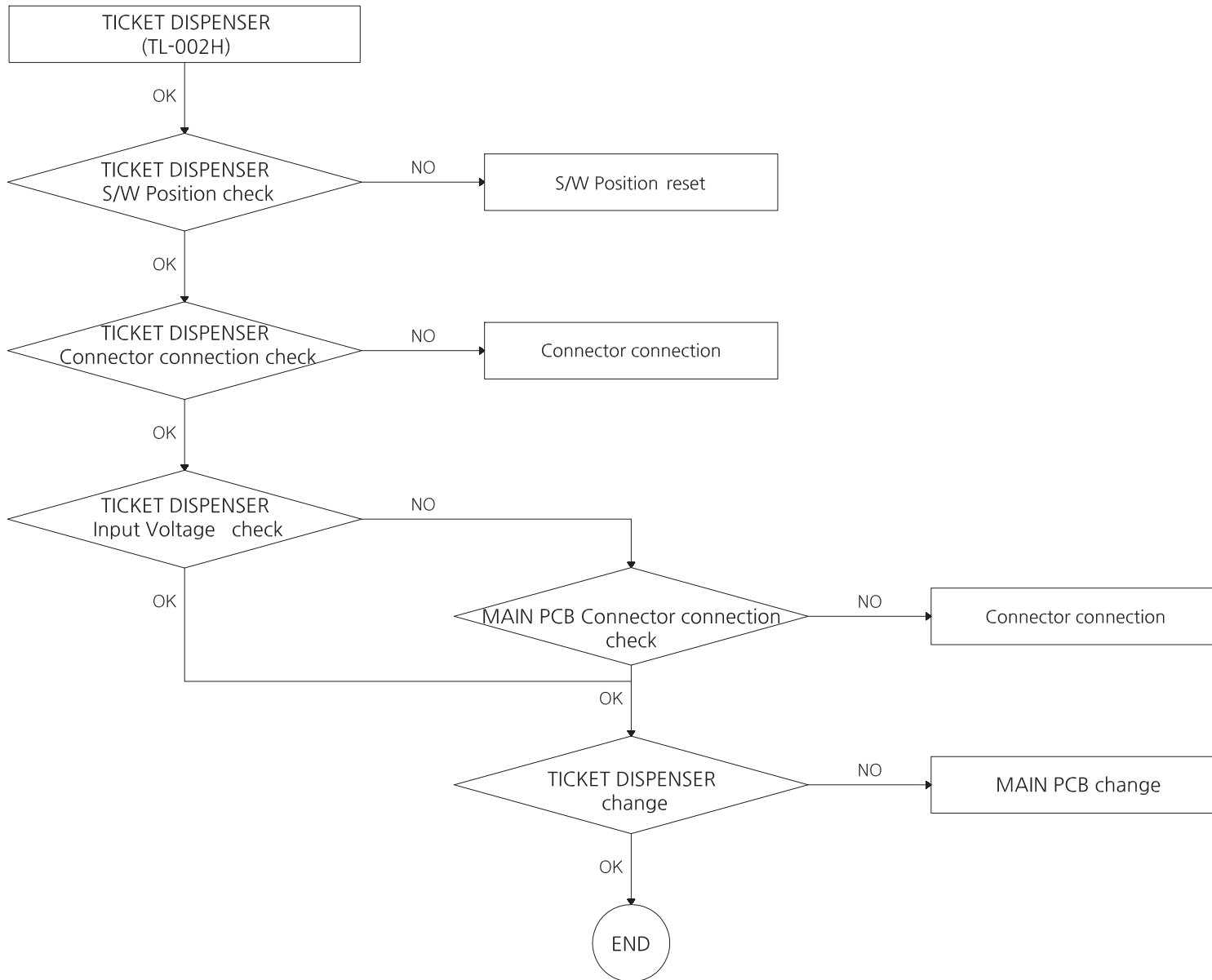

## 7-6. SOUND ERROR

\*Common: Check the input voltage, check wiring

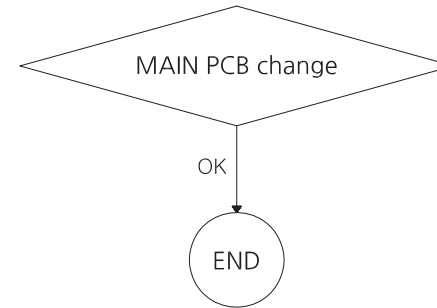
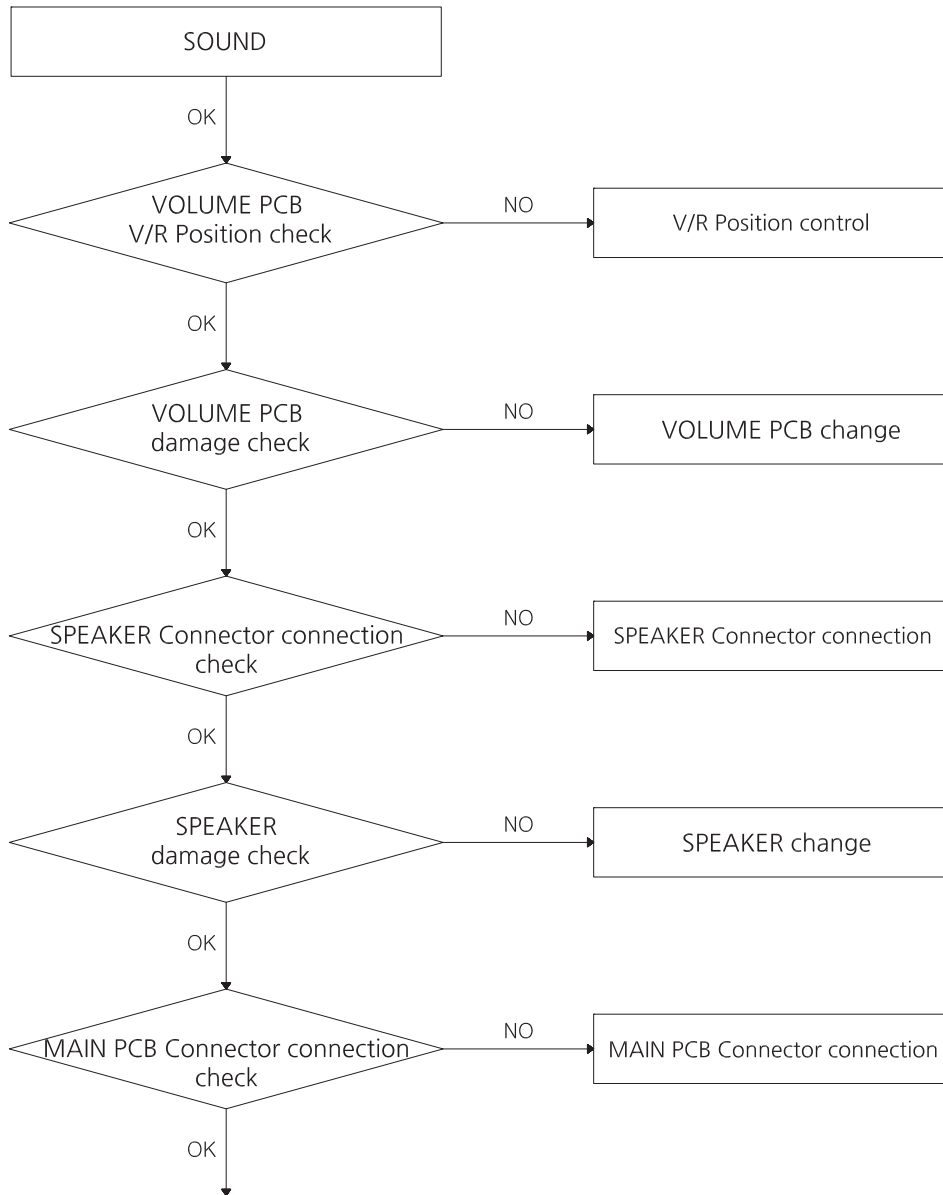

# 7-7. SETUP LCD PCB ERROR

\*Common: Check the input voltage, check wiring

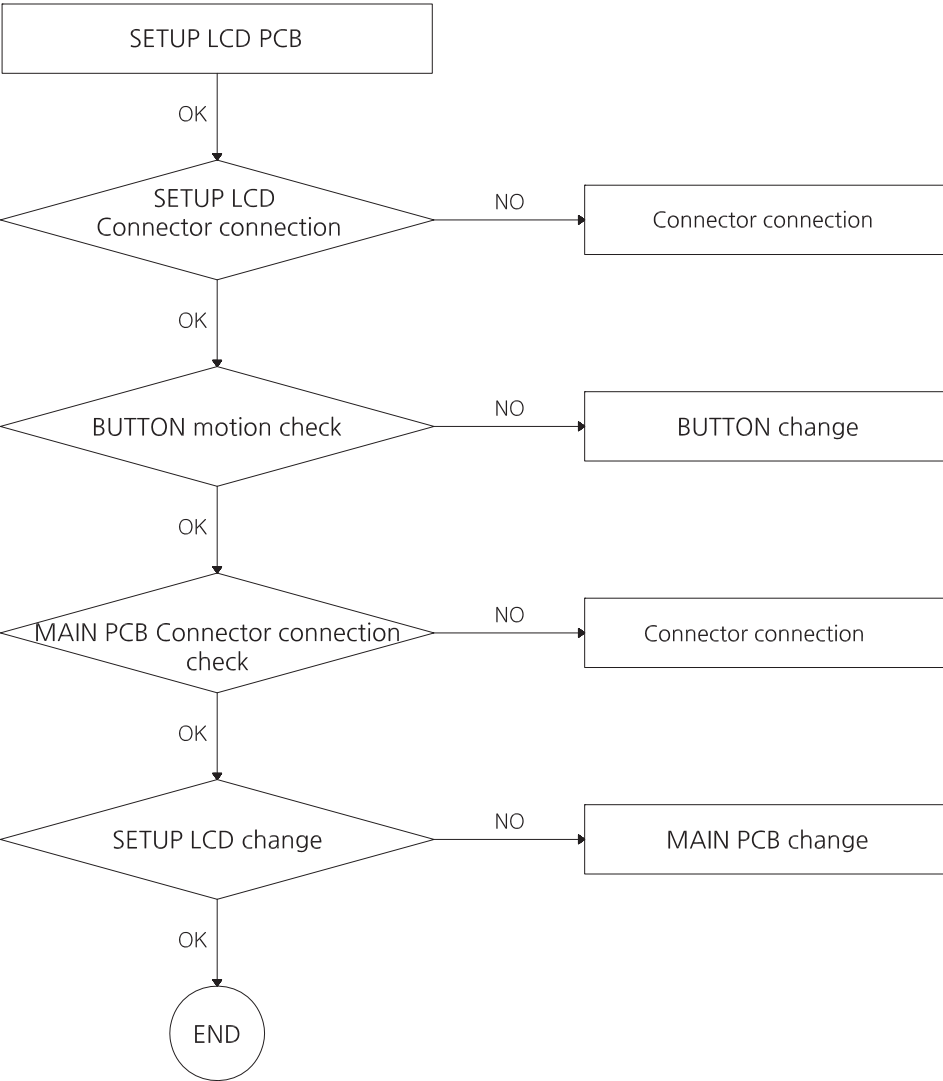

# 7-8. BUTTON & COUNTER ERROR

\*Common: Check the input voltage, check wiring

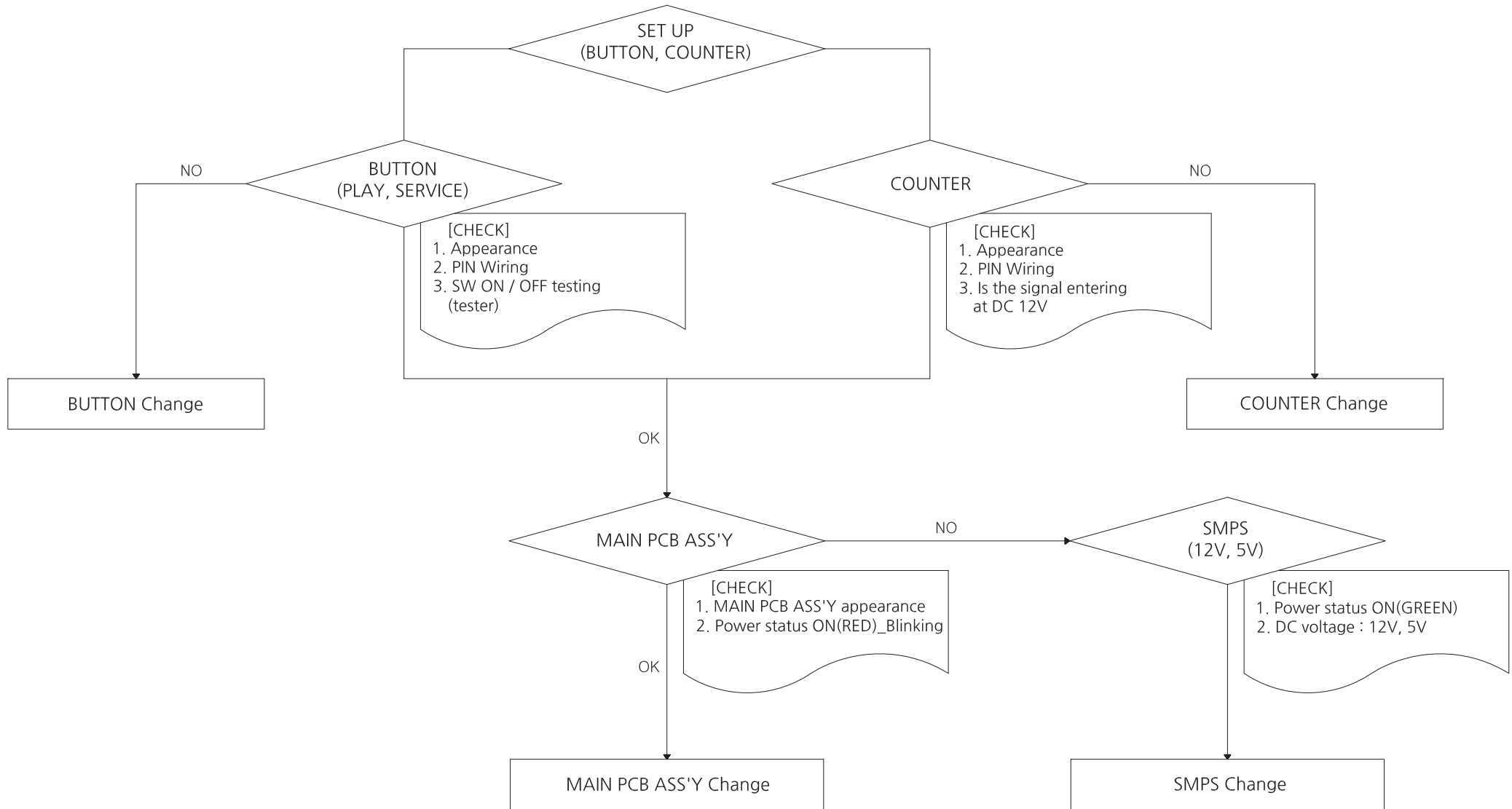

**7-9. MOUND LED, OUT LED L,R, LEFT SIDE LED, RIGHT SIDE LED, DROP LED, MAIN SPOT LED, SBO LED, HOMERUN DROP LED, BILLBOARD SPOT LED PCB / CREDIT FND, HIT OUT FND, TICKET FND, SCOR FND, 1ST~3RD FND, WIN FND, JACKPOT FND PCB ERROR**

\*Common: Check the input voltage, check wiring

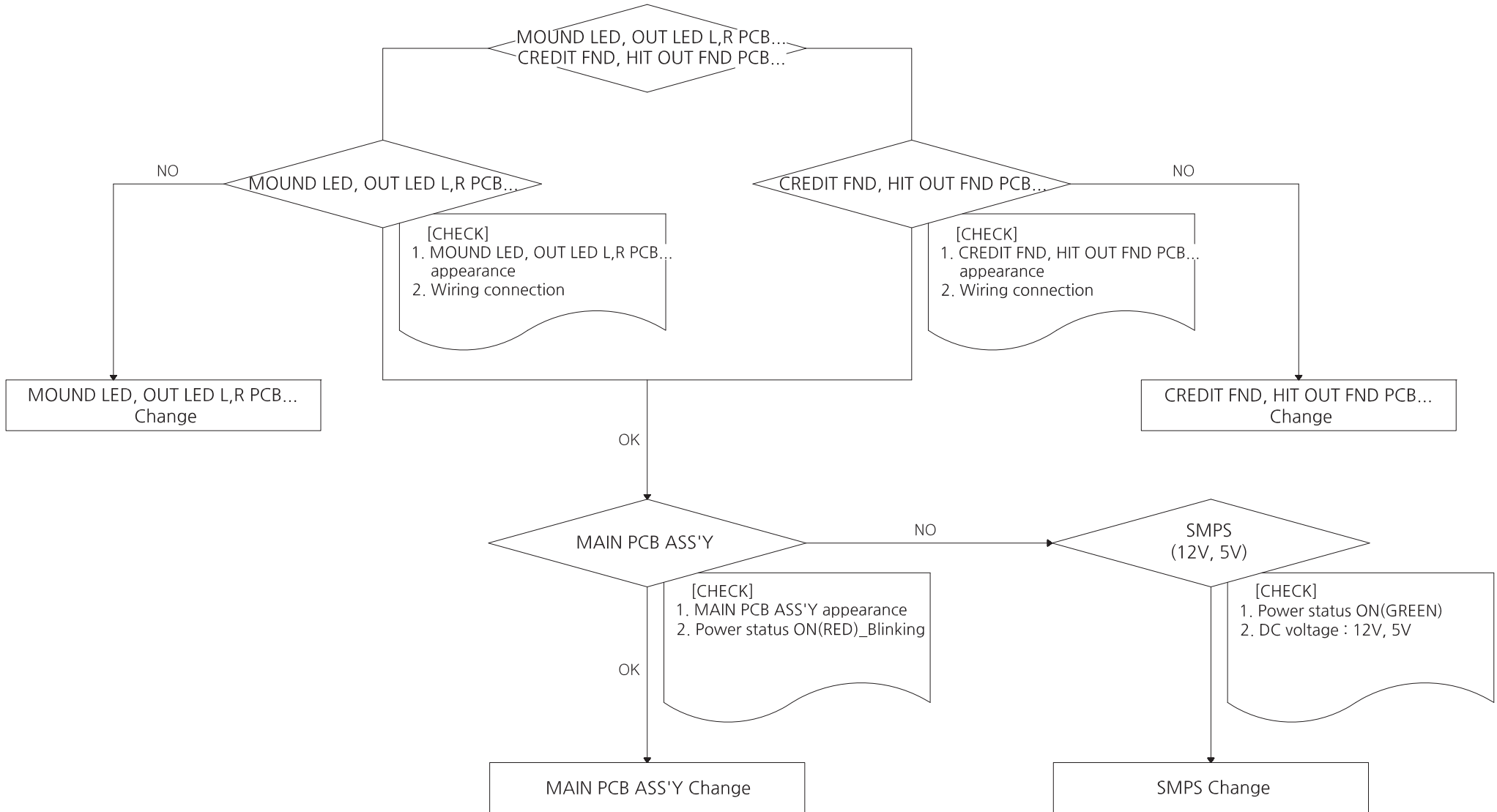

# 8. EXPLODED VIEW

## 8-1. MAIN CABINET PART

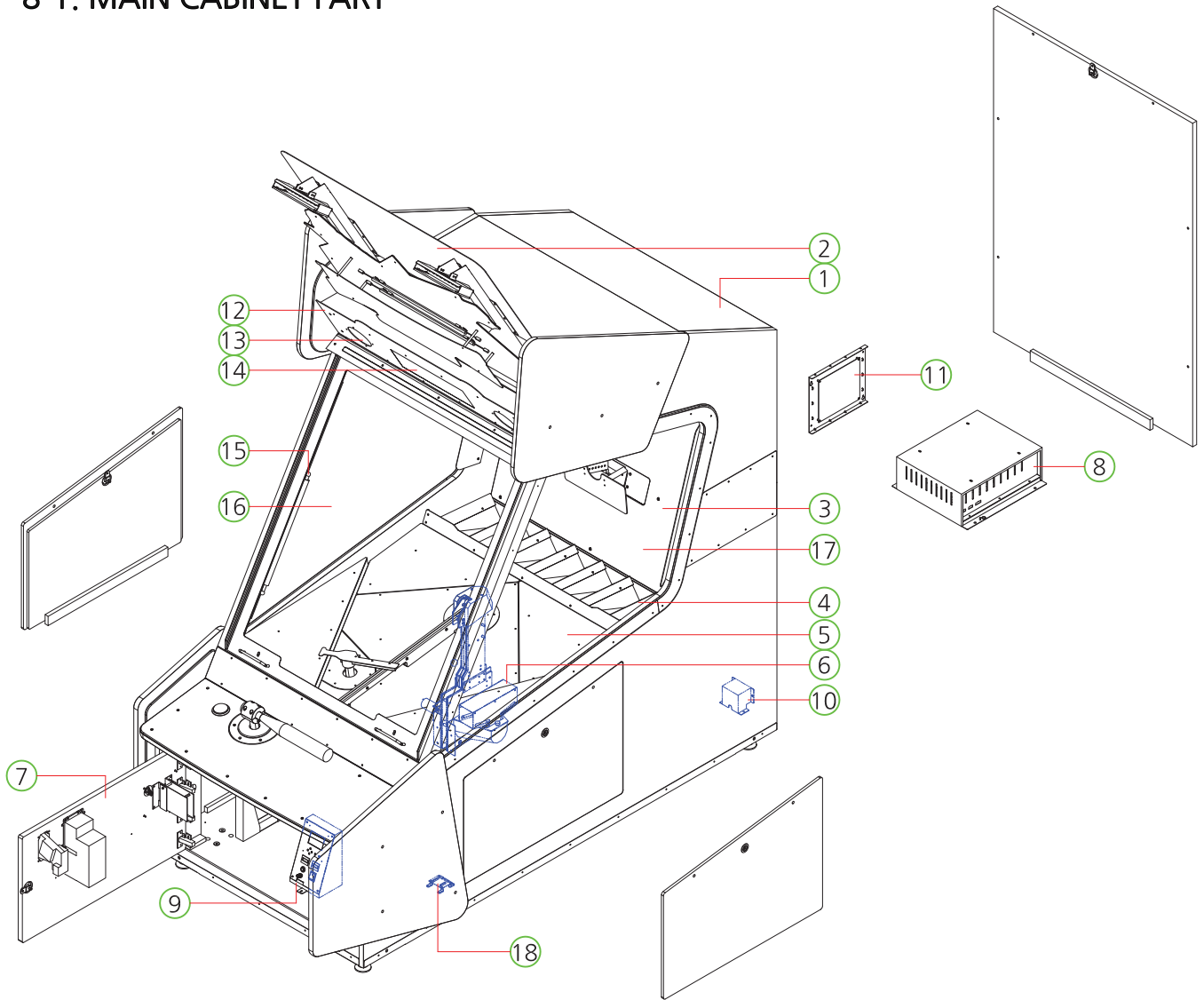

NO.	PART NAME	SPEC.	QUANTITY	CODE NO.
1	MAIN CABINET PART	-	1	-
2	BILLBOARD PART	-	1	-
3	BACKBOARD PART	-	1	-
4	DROP PART	-	1	-
5	GROUND PANEL PART	-	1	-
6	ELEVATOR PART	-	1	-
7	FRONT DOOR PART	-	1	-
8	POWER PART	-	1	-
9	SERVICE PANEL PART	-	1	-
10	AC INPUT PART	-	1	-
11	MAIN BOARD PART	-	1	-
12	SPEAKER PANEL ACRYL	-	1	MBAP0ACR011
13	SPEAKER	MID4"+TW1/2" 8OHM	2	MZZZ0SPE021
14	FND PCB ASS'Y	-	1	AFND0PCB024
15	SHOCK ABSORBER	GSB-22x761_15kg	2	MZZZ0SHO008
16	MAIN DOOR	-	1	MBAP0GLA001
17	SIDE WINDOW	ACRYL-5.0t	2	MBAP0ACR030
18	DISPLAY COPY PCB ASS'Y	-	1	AGST0PCB008

## 8-2. BILLBOARD PART

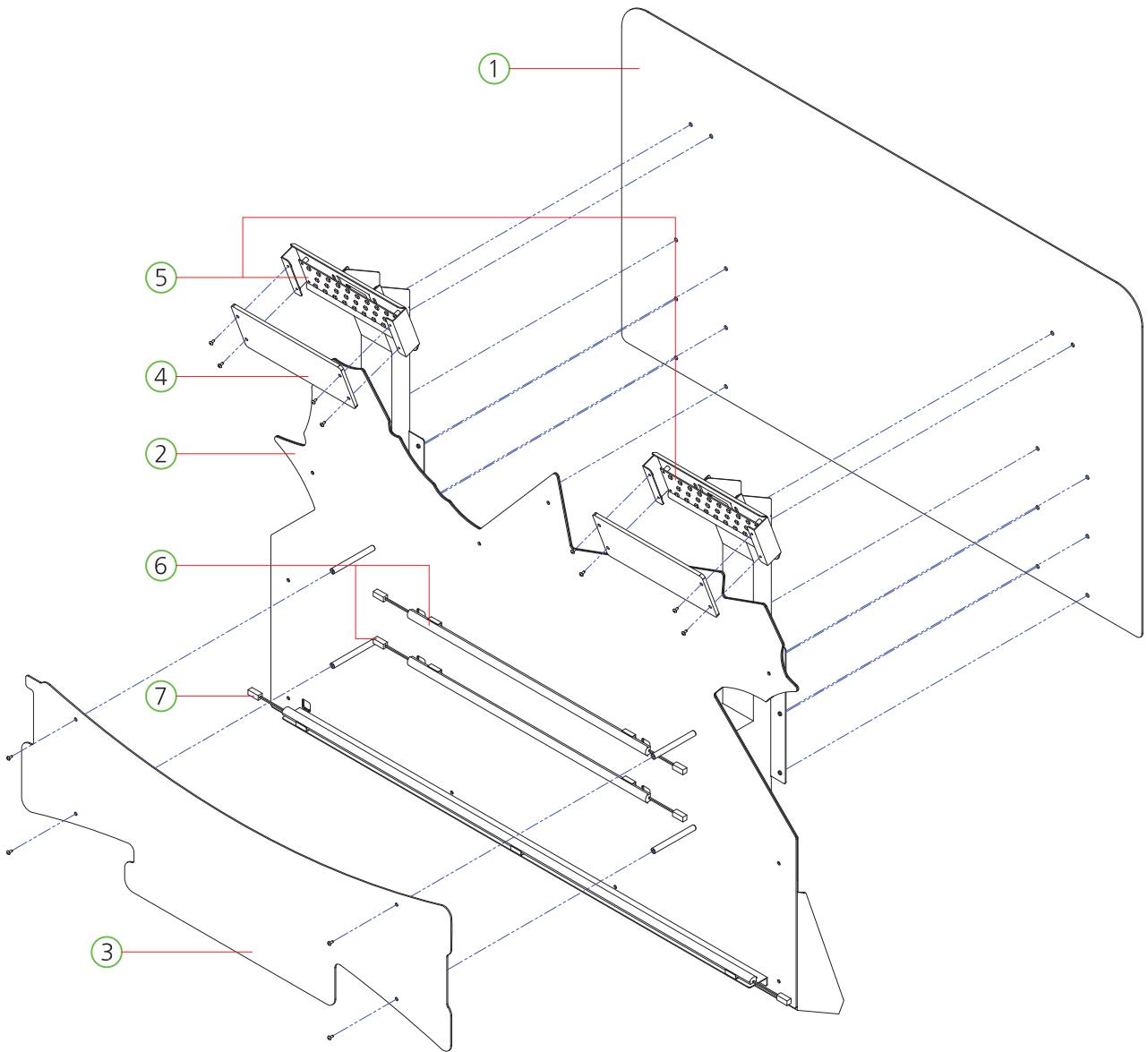

NO.	PART NAME	SPEC.	QUANTITY	CODE NO.
1	BILLBOARD BACKGROUND ACRYL	ACRYL-2.0t	1	MBAPOACR014
2	BILLBOARD BACK ACRYL	PET-2.0t	1	MBAPOACR003
3	BILLBOARD FRONT ACRYL	PET-2.0t	1	MBAPOACR004
4	SPOT ACRYL	ACRYL-5.0t	2	MBAPOACR031
5	SPOT LED PCB ASS'Y	-	2	ABAP0PCB008
6	LED BAR PCB ASS'Y	460mm	2	AZZZ0PCB124
7	LED BAR PCB ASS'Y	960mm	1	AZZZ0PCB128

### 8-3. BACKBOARD PART

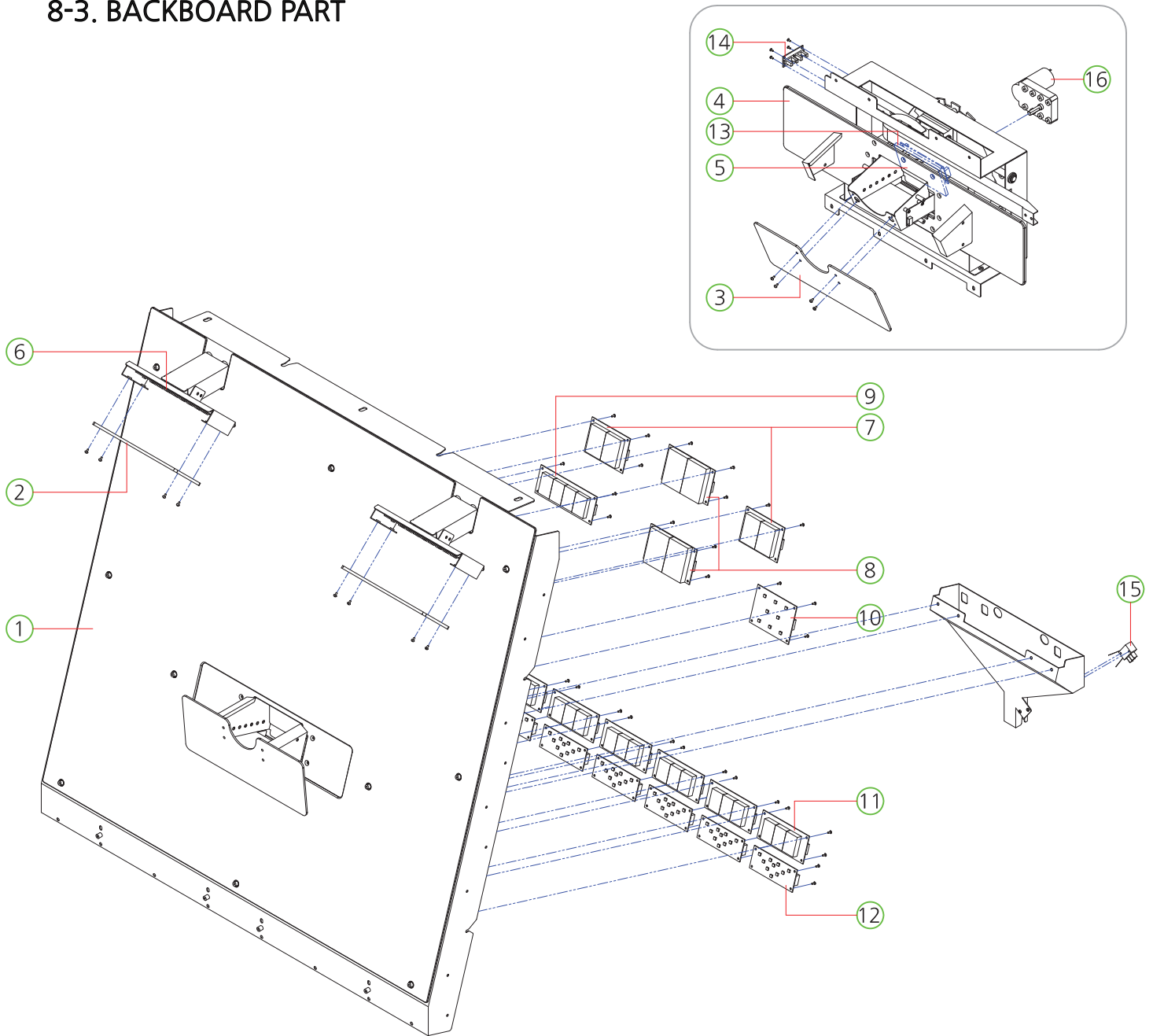

NO.	PART NAME	SPEC.	QUANTITY	CODE NO.
1	BACKBOARD ACRYL	ACRYL-3.0t	1	MBAP0ACR001
2	SPOT ACRYL	ACRYL-5.0t	2	MBAP0ACR031
3	HR BALL CASE DECO ACRYL	ACRYL-3.0t	1	MBAP0ACR006
4	HR BALL FRONT ACRYL	ACRYL-5.0t	1	MBAP0ACR017
5	HR BALL CASE ACRYL	ACRYL-5.0t	1	MBAP0ACR035
6	SPOT LED PCB ASS'Y	-	2	ABAP0PCB008
7	FND PCB ASS'Y	-	2	AFND0PCB006
8	FND PCB ASS'Y	-	2	AFND0PCB008
9	FND PCB ASS'Y	-	1	AFND0PCB004
10	SBO LED PCB ASS'Y	-	1	ABAP0PCB005
11	FND PCB ASS'Y	-	7	AFND0PCB012
12	DROP LED PCB ASS'Y	-	7	AFND0PCB013
13	DROP LED PCB ASS'Y	-	1	AFND0PCB013
14	PHOTO INT2 PCB ASS'Y	-	1	AWIW0PCB009
15	MICRO SWITCH	CNR-05H-03(ZIPPY-COIN)	1	MLELE0MIC002
16	MOTOR	KGE-3657-308/NB1-3657-065 /DC12V 17.8RPM "F"TYPE	1	MZZZ0MOT099



## 8-4. DROP PART

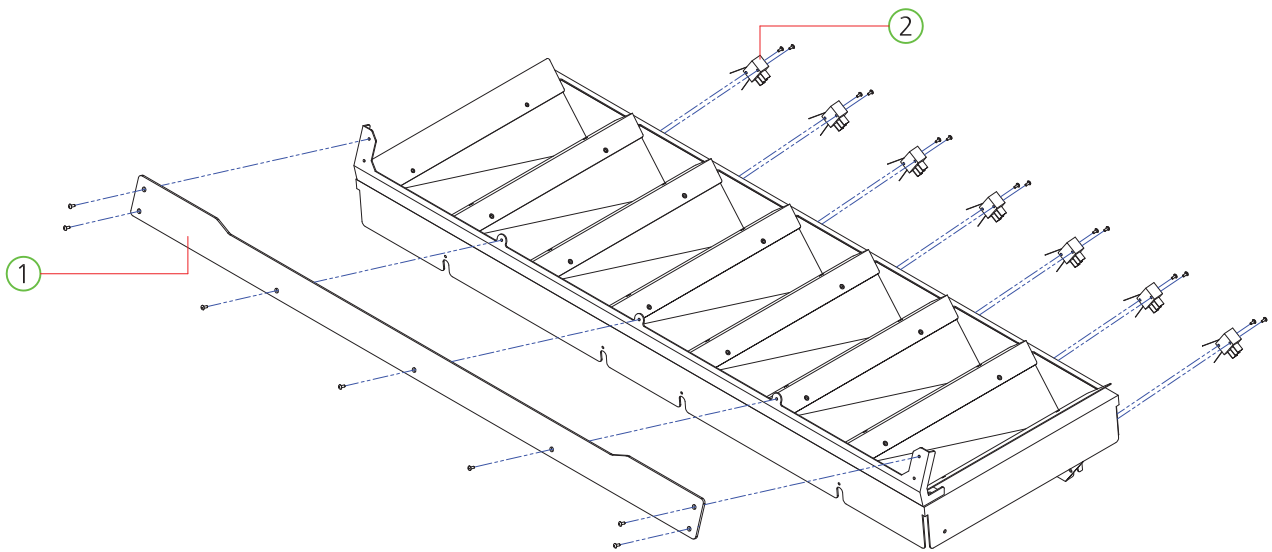

NO.	PART NAME	SPEC.	QUANTITY	CODE NO.
1	DROP FENCE ACRYL	ACRYL-3.0t	1	MBAP0ACR018
2	MICRO SWITCH	CNR-05H-03(ZIPPY-COIN)	7	MLELE0MIC002

## 8-5. GROUND PANEL PART

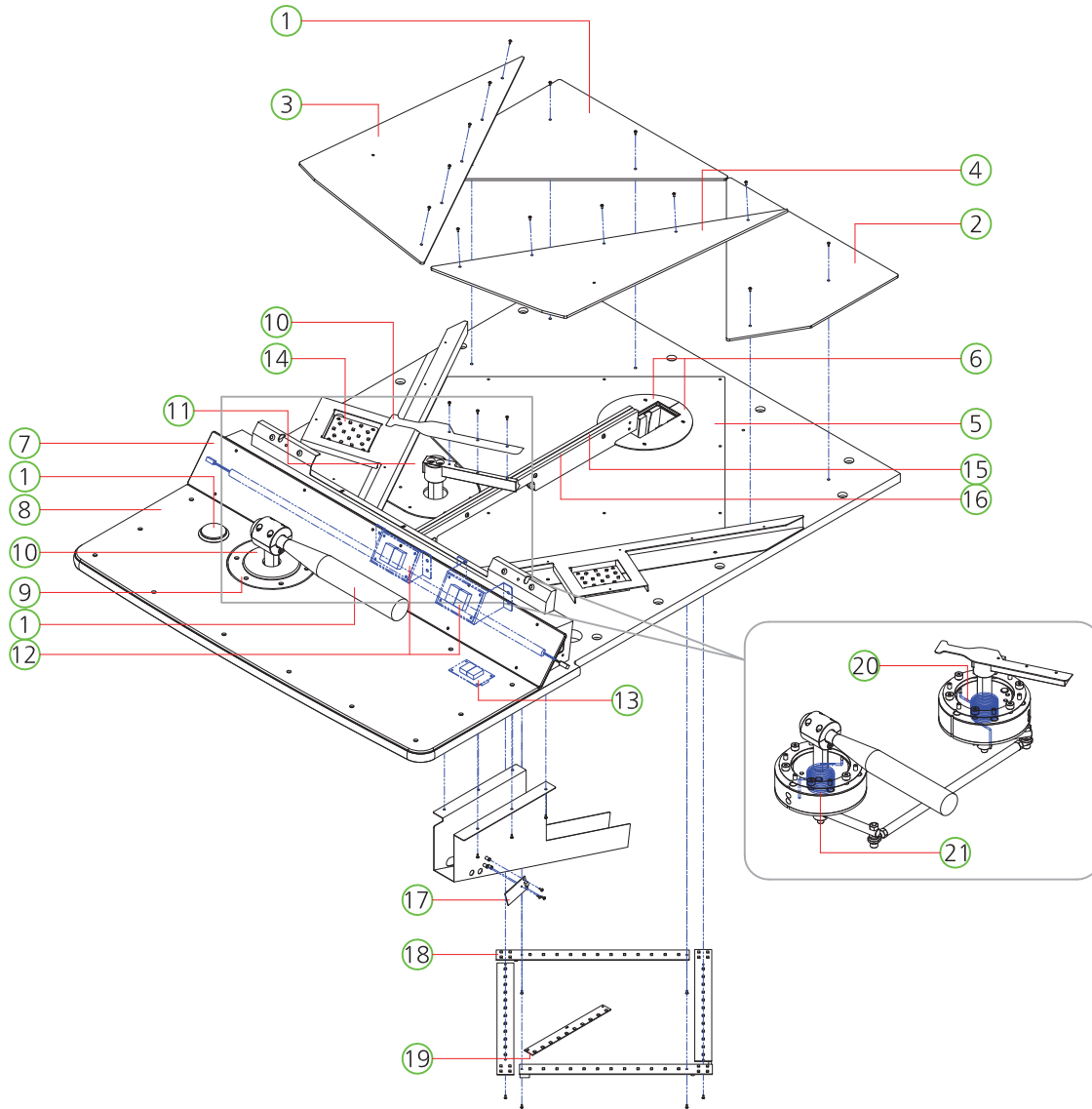

NO.	PART NAME	SPEC.	QUANTITY	CODE NO.
1	OUTFIELD ACRYL-L	ACRYL-5.0t	1	MBAP0ACR039
2	OUTFIELD ACRYL-R	ACRYL-5.0t	1	MBAP0ACR010
3	BENCH ACRYL-L	ACRYL-5.0t	1	MBAP0ACR038
4	BENCH ACRYL-R	ACRYL-5.0t	1	MBAP0ACR002
5	INFIELD ACRYL	ACRYL-5.0t	1	MBAP0ACR007
6	MOUND ACRYL	PET-2.0t	2	MBAP0ACR009
7	FRAME COVER ACRYL-L	ACRYL-5.0t	1	MBAP0ACR032
8	CONTROLLER PANEL ACRYL	ACRYL-5.0t	1	MBAP0ACR005
9	CONTROLLER SHAFT COVER ACRYL	ACRYL-5.0t	1	MBAP0ACR041
10	BAT COVER ACRYL	PET-2.0t	1	MBAP0ACR037
11	BAT SHAFT COVER ACRYL	ACRYL-5.0t	1	MBAP0ACR042
12	FND PCB ASS'Y	-	2	AFND0PCB001
13	FND PCB ASS'Y	-	1	AFND0PCB001
14	OUT LED PCB ASS'Y	-	2	ABAP0PCB003
15	CENTER RAIL ACRYL	ACRYL-10.0t	1	MBAP0ACR012
16	SIDE RAIL ACRYL	ACRYL-8.0t	2	MBAP0ACR029
17	ELEVATOR SENSOR PCB ASS'Y	-	1	ABAP0PCB002
18	MOUND LED PCB ASS'Y	-	4	ABAP0PCB004
19	MOUND CENTER LED PCB ASS'Y	-	1	ABAP0PCB014
20	SPRING	PW / SPRING_3.5PI	1	MBAP0SPR003
21	SPRING	PW / SPRING_4PI	1	MBAP0SPR001

## 8-6. ELEVATOR PART

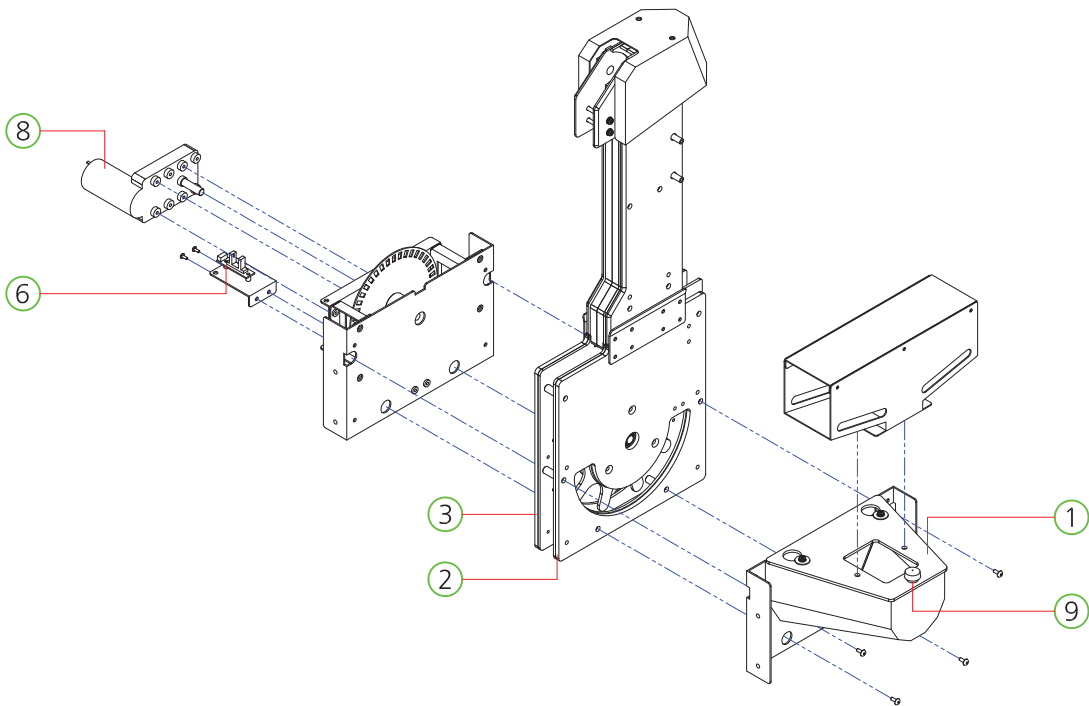
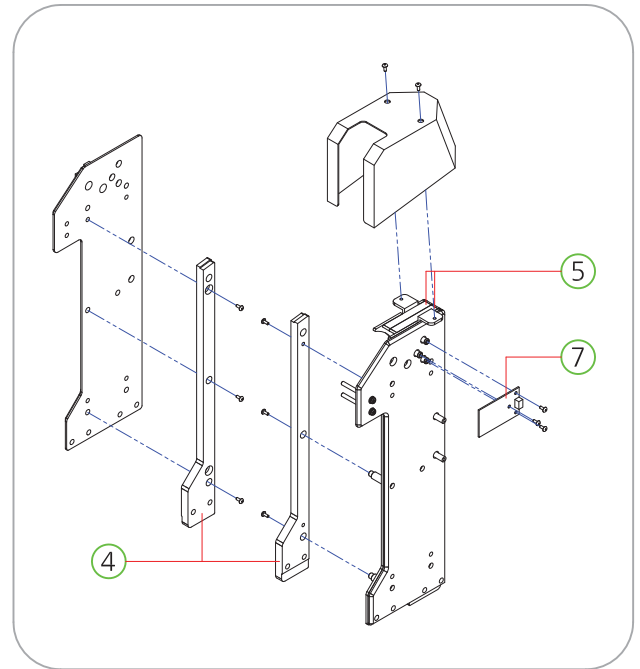

NO.	PART NAME	SPEC.	QUANTITY	CODE NO.
1	ELEVATOR CASE COVER ACRYL	ACRYL-3.0t	1	MBAP0ACR021
2	ELEVATOR BODY COVER ACRYL-R	ACRYL-5.0t	1	MBAP0ACR020
3	ELEVATOR BODY COVER ACRYL-L	ACRYL-5.0t	1	MBAP0ACR019
4	ELEVATOR RAIL FRONT ACRYL	ACRYL-10.0t	2	MBAP0ACR024
5	ELEVATOR RAIL REAR ACRYL	ACRYL-10.0t	2	MBAP0ACR025
6	PHOTO INT PCB ASS'Y	-	1	AZZZ0PCB103
7	BP BALL SENSOR PCB ASS'Y 2SENSOR	-	1	ABAP0PCB015
8	MOTOR	KGE-3657-615/NB1-3657-065 /DC12V 8.9RPM "F"TYPE	1	MZZZ0MOT100
9	HAND BOLT	M4x10L	1	MZZZ0PLA030

## 8-7. FRONT DOOR PART

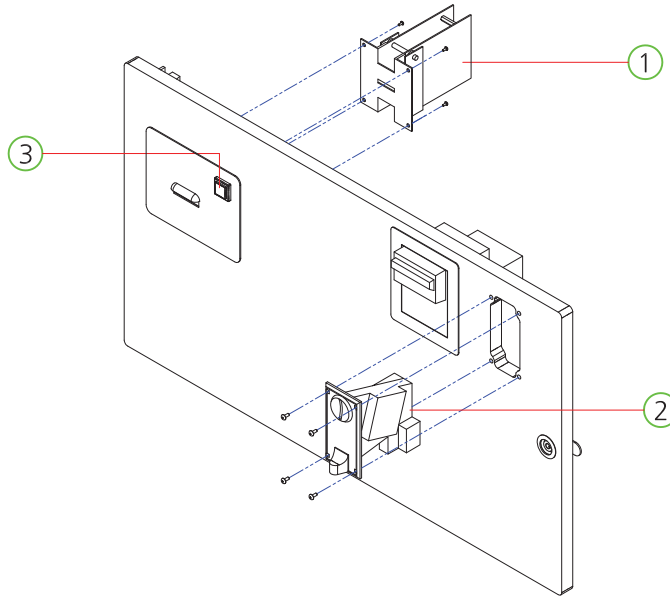

NO.	PART NAME	SPEC.	QUANTITY	CODE NO.
1	TICKET DISPENSER	TL-002H	1	MZZZ0TID007
2	COIN SELECTOR	TW-333	1	MZZZ0COS045
3	BUTTON SWITCH	AM1PB-26SH R12D	1	MMUM0BUT002

## 8-8. POWER PART

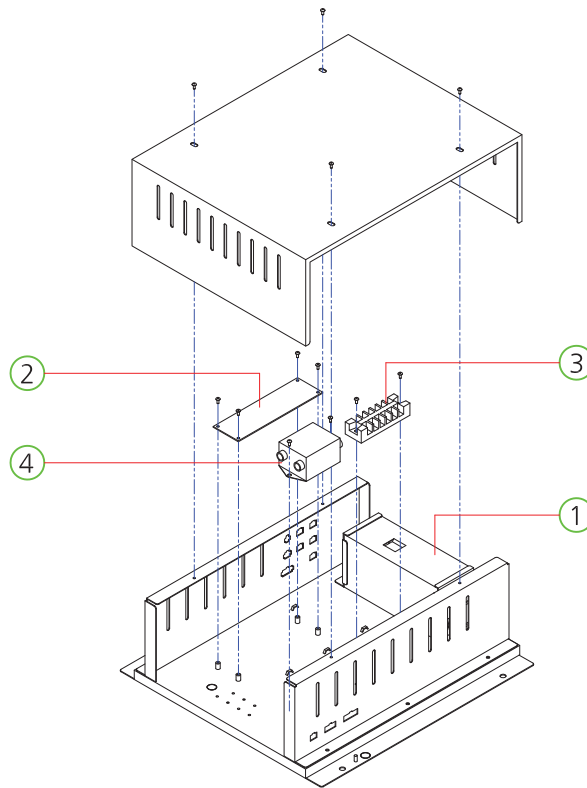

NO.	PART NAME	SPEC.	QUANTITY	CODE NO.
1	ATX POWER	SPC-350_UL POWEREX	1	MELE0SMP062
2	ATX JOIN 2 OZ PCB ASS'Y	-	1	ASUP0PCB008
3	TERMINAL BLOCK	KTB1-02006 250V 6P_20A	1	MELE0TEB001
4	NOISE FILTER	ES1-F10	1	MELE0NOI006

## 8-9. SERVICE PANEL PART

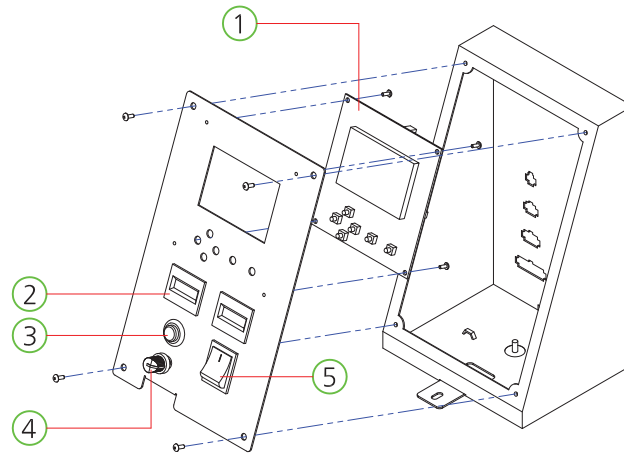

NO.	PART NAME	SPEC.	QUANTITY	CODE NO.
1	SETUP LCD PCB ASS'Y	-	1	AZZZ0PCB113
2	COUNTER	AMMC-712(OA127CL)	2	MZZZ0COU002
3	PUSH BUTTON SWITCH	DS-412R ROSH	1	MELE0PUS006
4	VOLUME KONB	-	1	MELE0VOL007
5	ROCKER SWITCH	T-125 4P	1	MELE0SWI004

## 8-10. AC INPUT PART

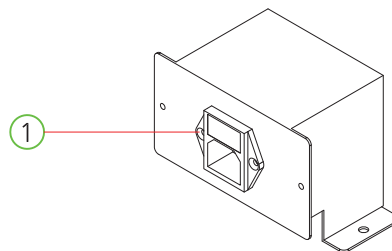

NO.	PART NAME	SPEC.	QUANTITY	CODE NO.
1	AC INPUT	DAC-13H WITH FUSE	1	MELE0SWI015

# 8-11. MAIN PCB PART

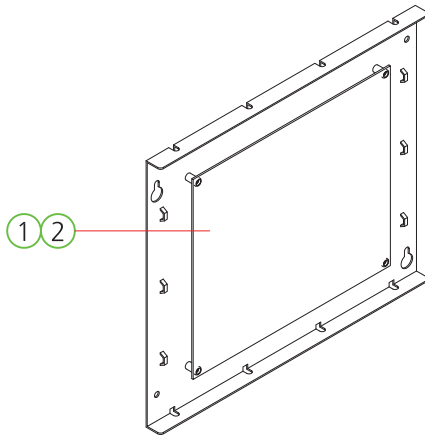

NO.	PART NAME	SPEC.	QUANTITY	CODE NO.
1	MAIN PCB ASS'Y	-	1	ABAP0PCB007
2	MEMORY PCB ASS'Y	-	1	ABAP0PCB011

## \* SPOT 26 LED BKT

SPEC. : BLACK-FN004K

MARK DATE DESIGNER DESIGNED BY CHECKED BY APPROVED BY

SECTION A-A

NOTE

1. Smoothen shorten-edge C0.1~0.3mm 카운트 모서리 제거 C 0.1~0.3
2. Unmarked corner chamfer C3.0, corner round R3.0 (표시되지 않은 모서리 C3.0, 라운드 R3.0)
3. Unmarked R is 96. R naturally is produced with bending (표시되지 않은 R은 96mm까지 생기는 것임)
4. Need to meet Rohs regulation(RoHS 기준 충족할 것)

Start	Grade	1st Grade	C2nd Grade	3rd Grade
0.5 over 3 under		±0.05	±0.1	±0.2
6 over 30 under		±0.1	±0.2	±0.5
30 over 120 under		±0.05	±0.3	±0.9
120 over 345 under		±0.2	±0.5	±1.2
345 over 1000 under		±0.3	±0.8	±2
1000 over		±0.5	±1.2	±3

1 SPOT LED BKT				2 SPCC L21		BLACK-FN004K
NO.	DESCRIPTION	QTY	MATERIAL	SPECIFICATION		
DRAWN BY	DESIGNED BY	CHECKED BY	APPROVED BY	SCALE	1:1	DATE   2016-05-26
GS HEO				ITEM	BASEBALL PRO CHALLENGE	
				DIVL. NAME	SPOT LED BKT	
				DIVL. NO.	MBACOME044	
				CODE NO.		

AM 1297 x 2100

- CAUTION

; DRY LOCATION ONLY  
; USE ONLY WITH CLASS 2 POWER UNIT

SERVICE BOX Ass'y

SETUP BUTTON & LCD

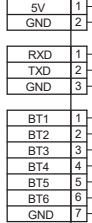

[5-2]

[5-1]



COUNTER



[6-2]

[6-1]



[8-1]

SERVICE BUTTON



[8-2]

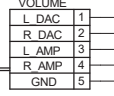

[7-2]

[7-1]

AC S/W



[1-4]

[1-5]

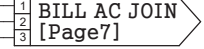

POWER BOX Ass'y

[1-6]

[2-4]

AC INLET



[1-2]

NOISE FILLTER



[2-1]

AC TERMINAL



[2-2]

[2-3]

ATX POWER

100-120V, 50/60Hz, 6A  
200-240V, 50/60Hz, 4A

MAIN BOARD PCB 1/7

[11-3]

F.G

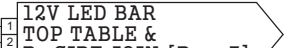
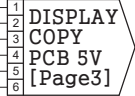
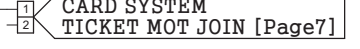

ATX JOIN PCB

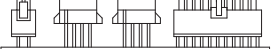

Title <b>BASEBALL PRO</b>		
Size A2	Number	Rev
Date 20160509 (Rev20160509)	by	
Filename	Sheet 1	of 7

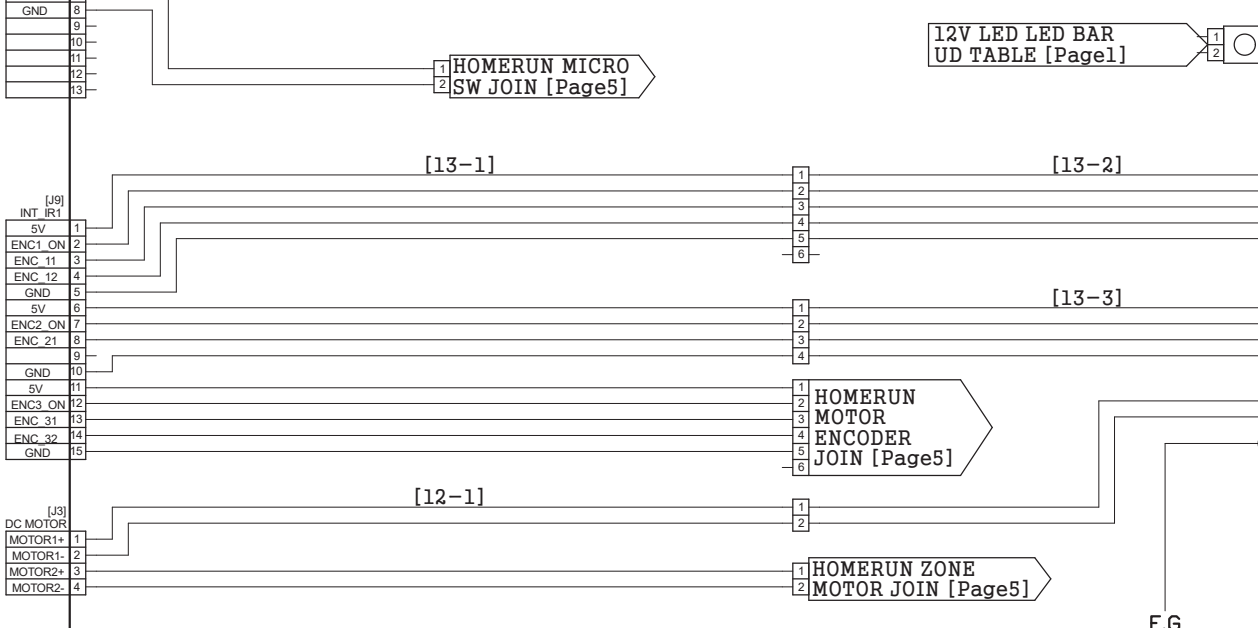
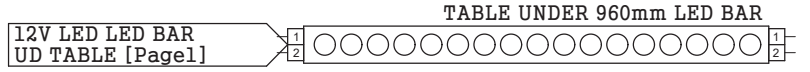
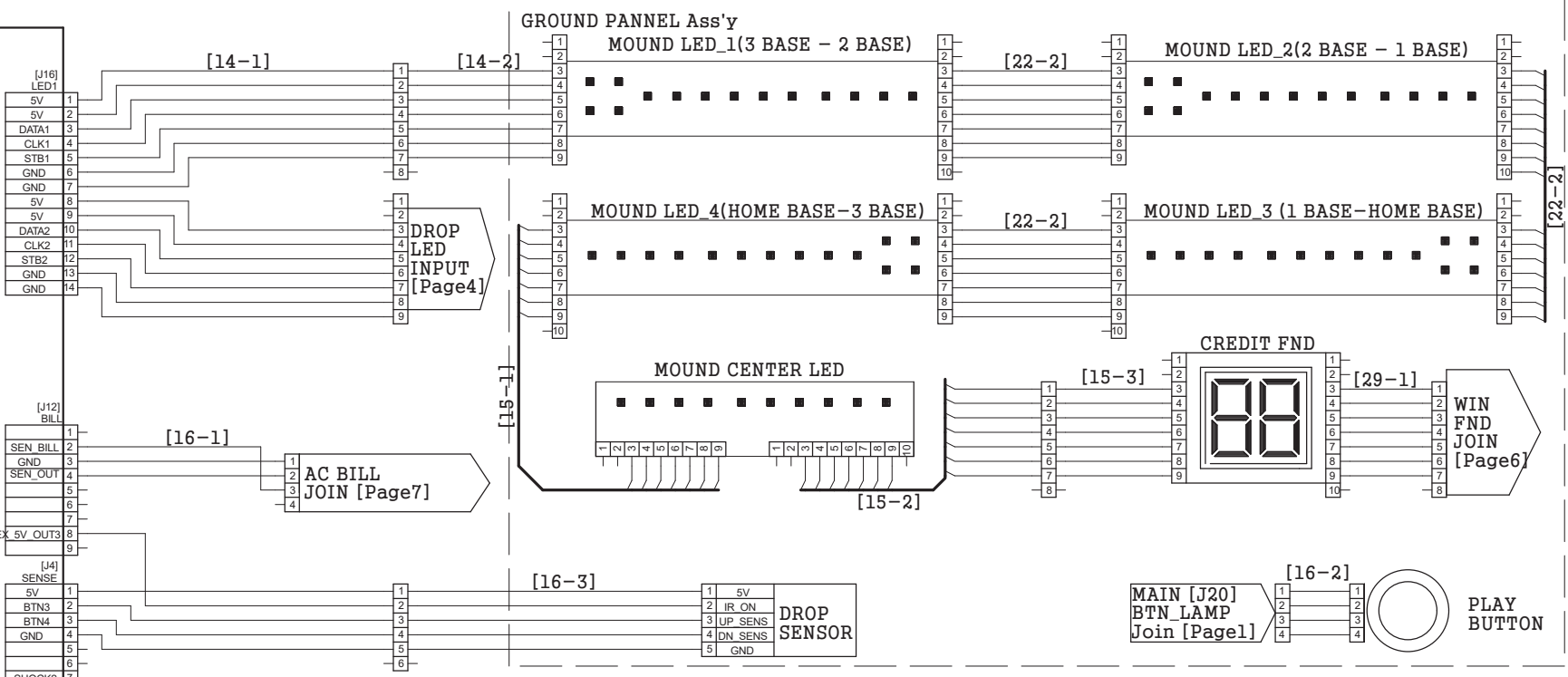
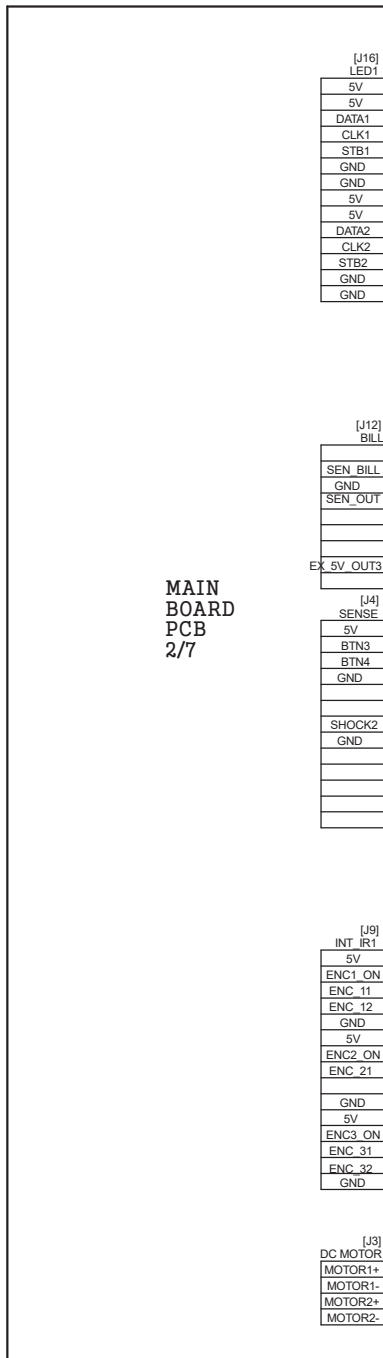

Title <b>BASEBALL PRO</b>		
Size A2	Number	Rev
Date 20160509 (Rev20160504)	by	
Filename	Sheet 2	of 7



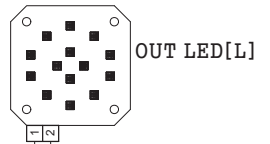
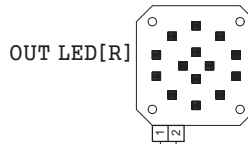
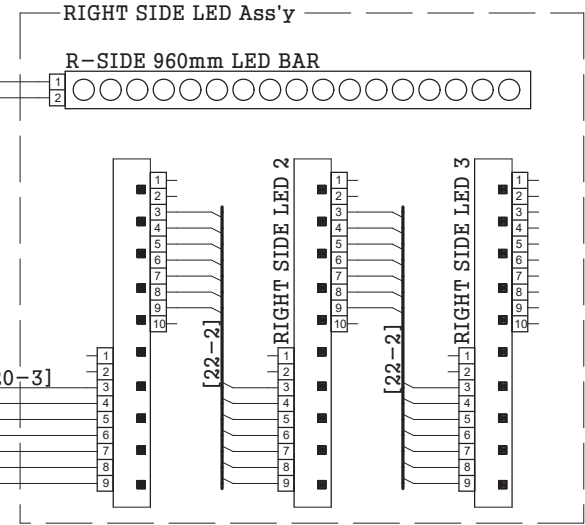
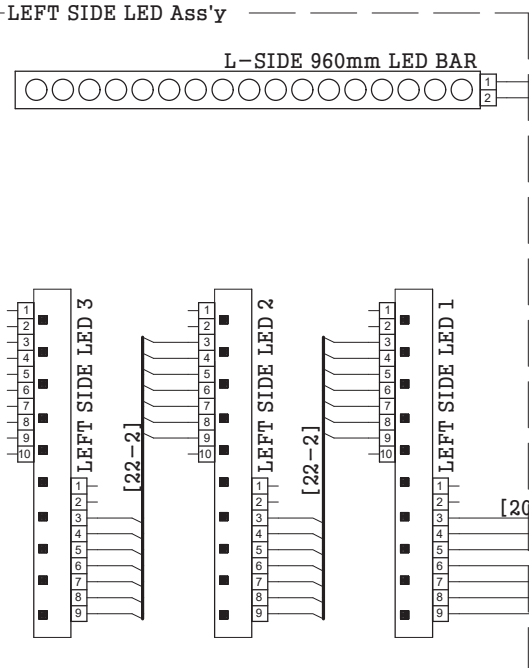
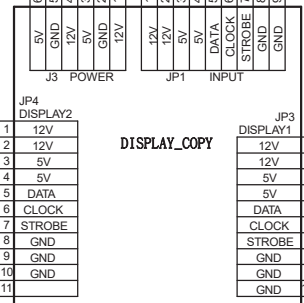
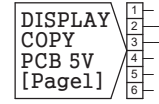
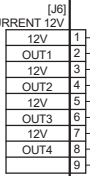
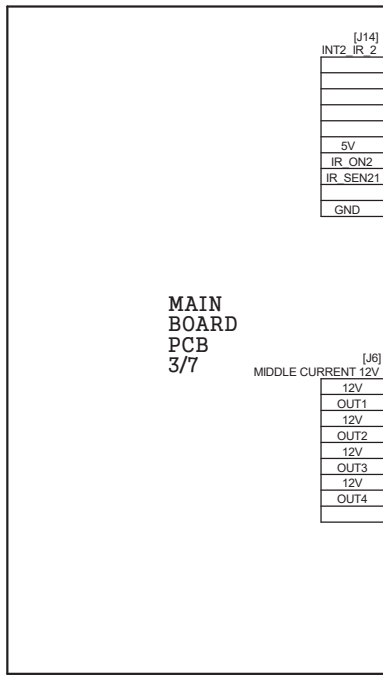

Title <b>BASEBALL PRO</b>		
Size A2	Number	Rev
Date 20160509 (Rev20160504)	by	
Filename	Sheet 3	of 7

MAIN BOARD PCB 4/7

[J7] LED2

12V	1
12V	2
5V	3
5V	4
DATA3	5
CLK3	6
STB3	7
	8
GND	9
GND	10
	11

[J5] EX-IN

GOAL 1	1
GOAL 2	2
GOAL 3	3
GOAL 4	4
GOAL 5	5
GOAL 6	6
GOAL 7	7
GND	8
	9

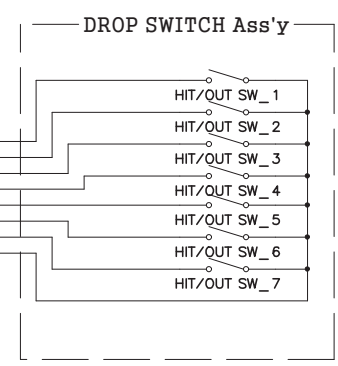
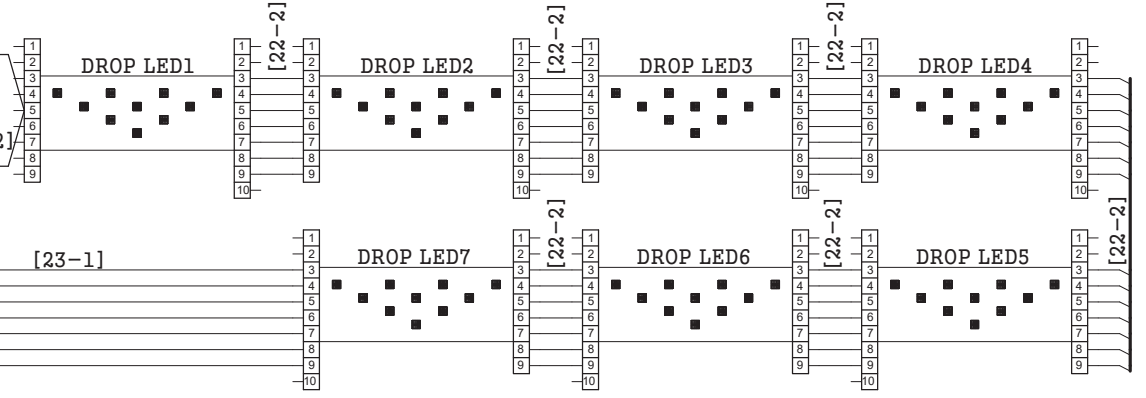
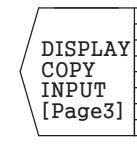
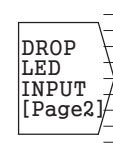
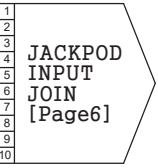
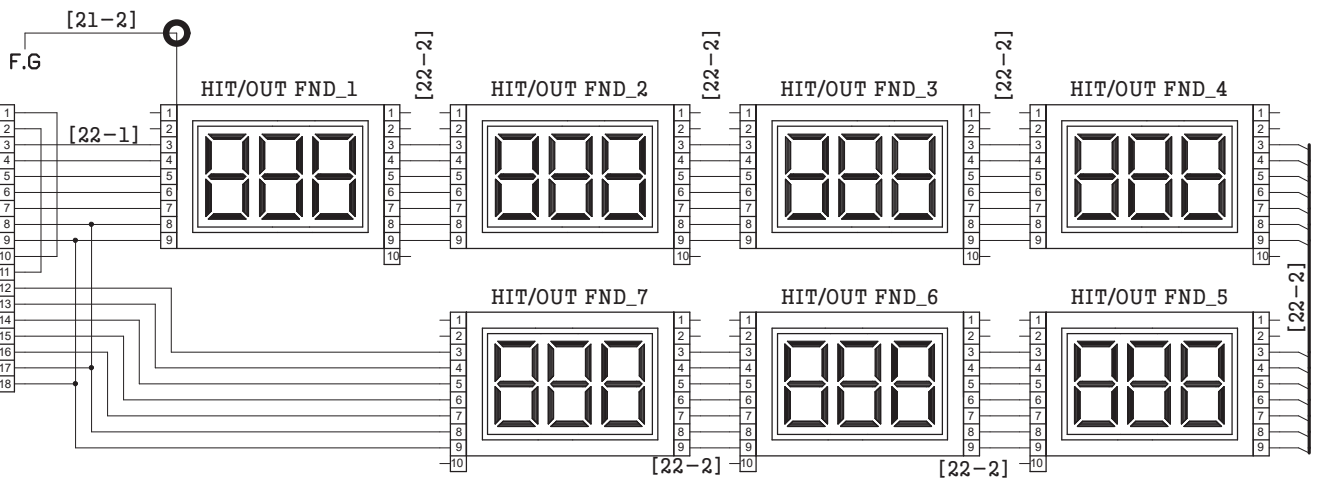

Title <b>BASEBALL PRO</b>		
Size A2	Number	Rev
Date	20160509 (Rev20160504) by	
Filename	Sheet 4	of 7

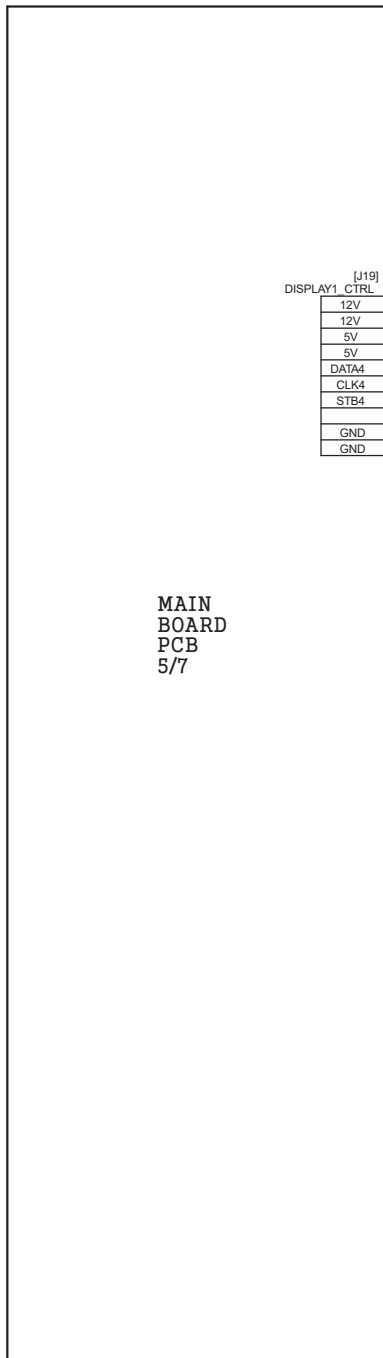

[J19] DISPLAY1\_CTRL

1	12V
2	12V
3	5V
4	5V
5	DATA4
6	CLK4
7	STB4
8	GND
9	GND
10	GND

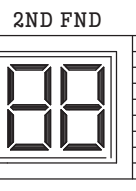
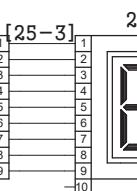
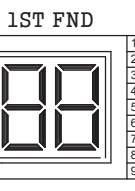
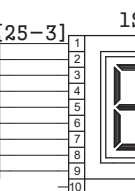
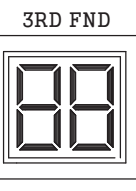
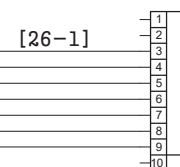
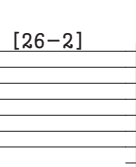
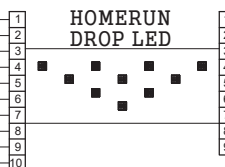
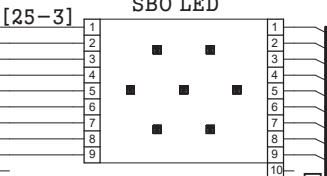
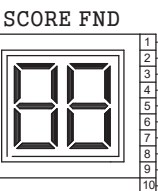
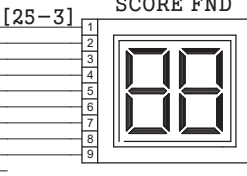
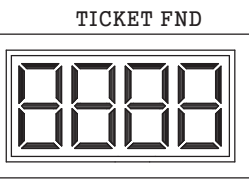
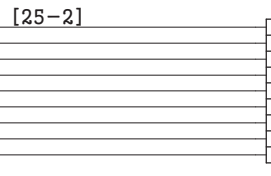
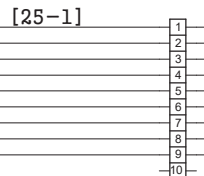
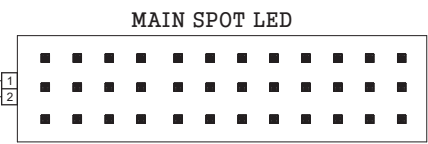
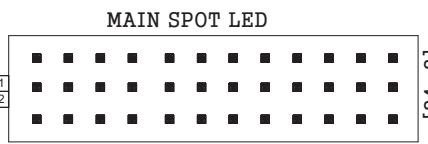

[25-4]

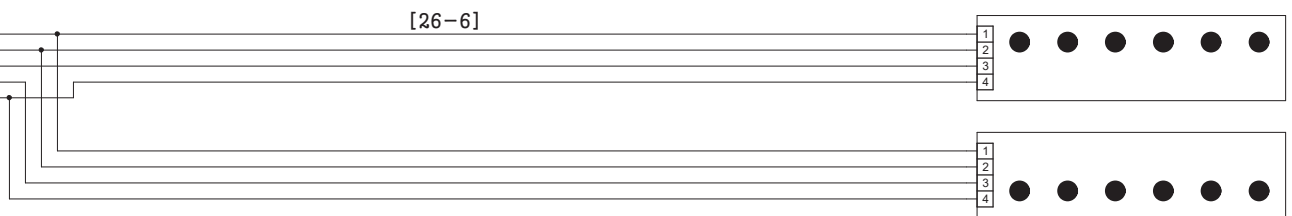

HOMERUN IR SENSOR

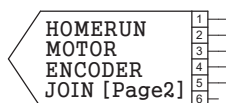

[26-5]

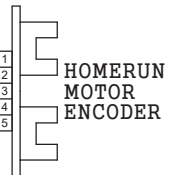

[26-4]



[26-3]

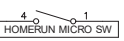

Title <b>BASEBALL PRO</b>		
Size A2	Number	Rev
Date 20160509 (Rev20160504)	by	
Filename	Sheet 5	of 7

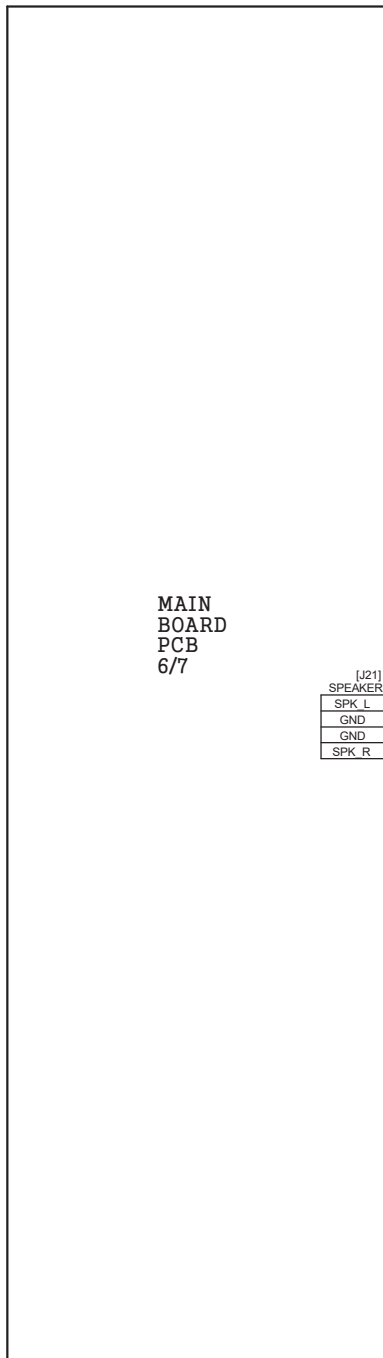

BILLBOARD SPOT LED  
MAIN CASE JOIN [Page3]

[18-4]

[27-1]

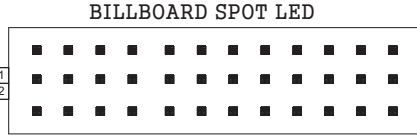

BILLBOARD SPOT LED

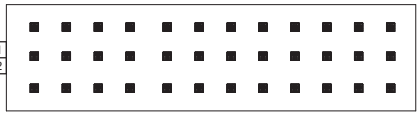

BILLBOARD 12V LED  
MAIN CASE JOIN [Page1]

[4-4]

[27-2]

BILLBOARD 450mm LED BAR 960mm LED BAR



BILLBOARD 450mm LED BAR



BILLBOARD 450mm LED BAR

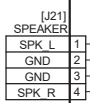

[27-3]

[27-4]

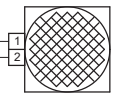

1  
2

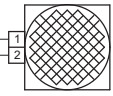

1  
2

[27-5]

JACKPOD  
INPUT  
JOIN  
[Page4]

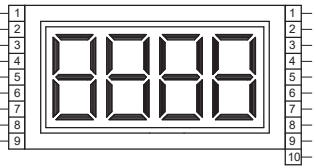

WIN  
FND  
JOIN  
[Page2]

[29-2]

WIN FND

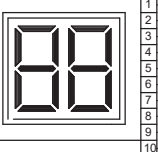

[29-3]

WIN FND2

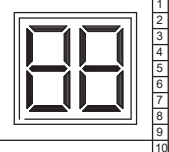

20160321 : FND 2종 추가

Title <b>BASEBALL PRO</b>		
Size A2	Number	Rev
Date	20160509 (Rev20160509) by	
Filename	Sheet	6 of 7

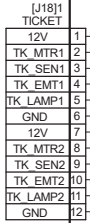
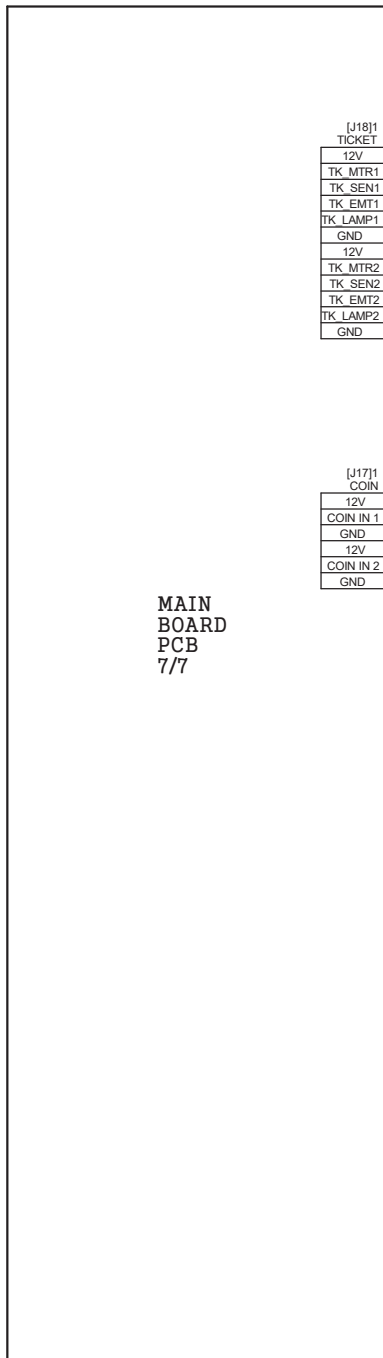

[9-1]



[9-2]

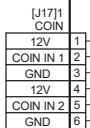
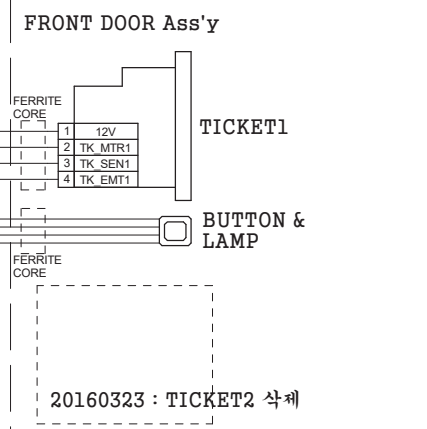

[10-1]

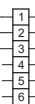

[10-2]

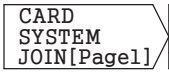
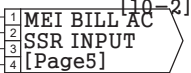

CARD SYSTEM JOIN [Page1]

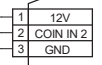
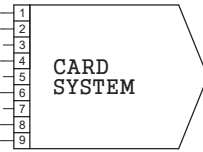

COIN\_1P

20160323 : COIN2 삭제

[11-2]

F.G



AC BILL JOIN [Page2]

[10-1]



BILL AC JOIN [Page1]



\* OPTION \*

75-250V, 47-65Hz, 8A



**MEI BILL AC SSR**

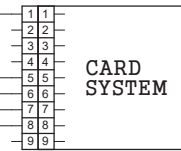

AC BILL F.G

Title <b>BASEBALL PRO</b>		
Size A2	Number	Rev
Date	20160509 (Rev20160509) by	
Filename	Sheet 7	of 7



## **ANDAMIRO WARRANTY POLICY**



Andamiro warrants to the original purchaser that all of its products will be free from defects in material and workmanship.

**Andamiro warrants the parts from date of shipment as follows.**

- **One Year Limited Warranty : Electronic Boards & Monitor**
- **6 Month Limited Warranty : Moving Parts**

For any key components within the warranty period, Andamiro will repair or replace defective components free of charge.

When placing a warranty request, the customer is requested to furnish the following information:

1. Name of the game.
2. Serial Number of the game.
3. A Detailed Description of the defect/s experienced.

This warranty does not apply to the defects caused due to misuse or abuse of the product.

Any alterations made to game or game parts will void this warranty.

For warranty details on our product range please visit our website, [www.andamiro.com](http://www.andamiro.com).

ANDAMIRO CO., LTD.  
[www.andamiro.com](http://www.andamiro.com)



Please complete the following request form to place a warranty request and send it to ANDAMIRO Korea either by fax (Fax No: +82-31-908-7548) or by e-mail. The e-mail address of the person in charge of each region is shown in our web-site, [www.andamiro.com](http://www.andamiro.com)

For the on-line request, please visit our web-site, [www.andamiro.com](http://www.andamiro.com) and click "Customer Service" and then click "Contact Us" in which you shall find the e-mail address of the person in charge of each region.

**1. Company Name :** \_\_\_\_\_

**2. Mailing Address :** \_\_\_\_\_

\_\_\_\_\_

**3. E-Mail Address :** \_\_\_\_\_

**4. Phone No :** \_\_\_\_\_

**5. Name of the person in charge :** \_\_\_\_\_

**6. Description of the product defects**

6-1 ) Name of the Game : \_\_\_\_\_

6-2 ) Serial No : \_\_\_\_\_

6-3 ) Date of Purchase : \_\_\_\_\_

6-4 ) Detailed description of the product defects.

\_\_\_\_\_

\_\_\_\_\_

\_\_\_\_\_

Remarks: If possible, please provide us with related photos and videos which will be greatly appreciated to verify the cause of the problem.

# BASEBALL<sup>TM</sup> PRO.

---

**ANDAMIRO CO., LTD.**

TEL : 82-31-909-2123~5

**[ADDRESS OFFICE]** 704-1 Techno Town, 138, Ilsan-ro, Ilsandong-gu, Goyang-si,  
Gyeonggi-do, Republic of Korea 10442

**[FACTORY]** 72 Nochemgil, Ilsan-donggu Goyang-si, Gyonggi-do, 410-834 korea

**USA BRANCH**

ANDAMIRO USA CORP.

TEL : 1-310-767-5800

**[ADDRESS]** 17230 S. Main Street Gardena, California 90248 U.S.A.

Homepage <http://www.andamiro.com/>